

LD30EPBR10BPxxIO - IO-Link



Photoelectric Laser sensor with BGS, FGS and IO-Link communication



Description

The LD30EPBR10BPxxIO are a part of the latest generation of high performance Photoelectric Laser sensors designed to solve challenging detection tasks due to Laser, Background Suppression, Foreground Suppression and Dual Detection features. The small light spot makes detection very precise.

The LD30EPBR10BPxxIO stainless steel sensors are manufactured with high-quality materials designed for harsh environments.

They are intended for use in environments where high-pressure cleaning (IP69K), cleaning agents and disinfectants are used daily, thanks to their ECOLAB approval.

The strong stainless steel (AISI316L) together with high-quality plastic materials like PMMA and PES sealings of FKM ensure a safe and excellent mechanical resistance.

The compact sensor design is ideally suited to confined spaces.

Benefits

- **Red laser class 1 assure reliable detection**
- **Red Laser BGS or FGS Long Range** sensor with IO-Link with an adjustable distance of 20 to 125 mm, either by Teach-button or via IO-Link.
- **Dual Detection mode** - Combine Foreground detection with Diffuse Reflective detection.
- **Triangulating sensing principle.**
- **Application functions:** Dual Detection, Pattern Recognition, Speed & Length, Divider function and Object & Gap Monitoring.
- **Neighbour Immunity**, select up to 3 neighboring sensors.
- **Easy customization** to specific OEM requests by use of the build in IO-Link functionalities.
- **The output can be operated** either as a standard switching output or in IO-Link mode.
- **Fully configurable via output IO-Link v 1.1.** Electrical outputs can be configured as PNP / NPN / Push-Pull / External input, normally open or normally closed.
- **Timer functions** can be set, such as ON-delay, Off-delay, and one shot.
- **Logging functions:** Temperature, detecting counter, power cycle and operating hours.
- **Detection modes** Background suppression (BGS), single point, two point, windows and foreground suppression (FGS) mode.
- **Logic functions:** AND, OR, XOR and Gated SR-FF.
- **Analogue output:** In IO-Link mode the sensor will generate 16 bit analogue process data output representing various selectable process data such as received signal level.

IO-Link

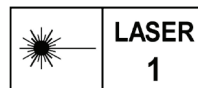

Applications

Detecting of transparent or translucent plastic bottles.

The detection distance is almost independent of the colour of the object to detect.

Dual Detection: A dual detection sensor works as a foreground suppression sensor combined with a diffuse reflective sensor. This sensing principle evaluates both the position change as well as the light intensity of the received light. This allow detection of eg. transparant PET bottles.



Pattern Recognition: An easy way to verify that a product is manufactured to the specification e.g. Furniture production where tabs or holes has to be with a defined pattern.

Speed and Length: Monitor the speed and length of an object on a conveyour for e.g. sorting on size.

Divider function: A de-central counting function that gives a signal when a preset count level is reached e.g. when a certain amount of items are packed in a carton box it ask for a new box.

Object and Gap Monitoring: Function that can sort out good objects and gaps between them so e.g. a packaging machine only receive objects with the correct size and gaps.

Main functions

- The detection distance is almost independent of the colour of the object to detect.
- The sensor can be operated in IO-Link mode once connected to an IO-Link master or in standard I/O mode.
- Measured sensing distance as process data.
- Neighbour interference protection.
- Sensing distance by teach-button, teach by wire or by IO-link parameter.
- Quality of Run and Quality of Teach result.
- Temperature data for preventive maintenance.
- Front-end check for preventive maintenance.
- Dual Detection

References

Product selection key



LD30EPBT10BP IO

Enter the code option instead of

Code	Option	Description
L	-	Sensing principle: Photoelectric laser sensor
D	-	Rectangular housing
30	-	Length of housing
E	-	Stainless steel
P	-	Teach-button
B	-	Background / Foreground suppression
R	-	Red light
10	-	Sensing distance: 100 mm
B	-	Selectable functions: NPN, PNP, Push-Pull, External Input (only pin 2) or External teach input (only pin 2)
P	-	Selectable: N.O. or N.C.
<input type="checkbox"/>	A2	Cable, 2 m
	M5	Connector M8 4-pin
IO	-	IO-Link version

**Type selection**

Conne- ction	Housing	Light type	Code
Cable	Stainless steel	Red laser class 1	LD30EPBR10BPA2IO
Plug	Stainless steel	Red laser class 1	LD30EPBR10BPM5IO

Structure

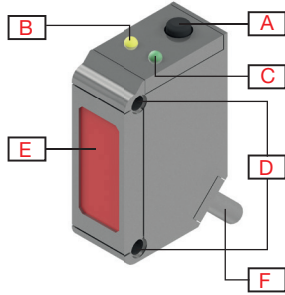

Fig. 1 Cable

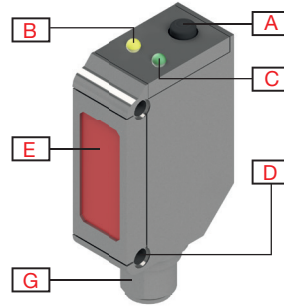

Fig. 2 Plug

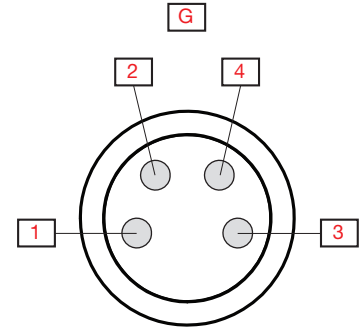
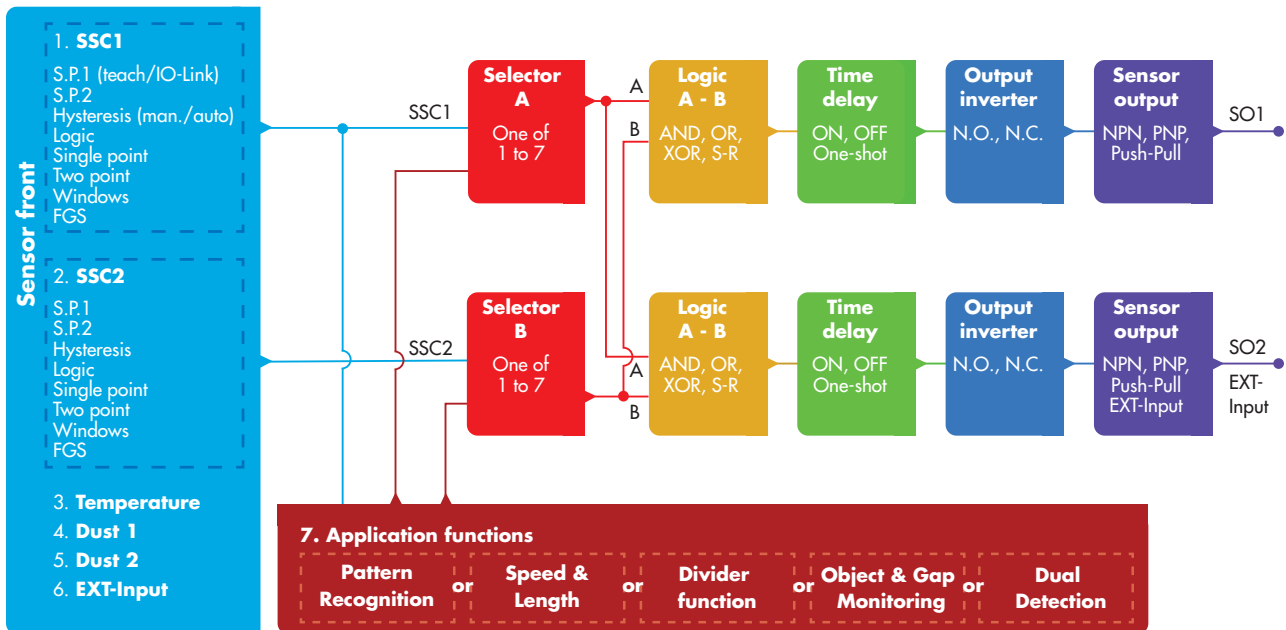

Fig. 3 "M8-plug" Pin numbers

A	Teach-button	G	M8, 4-pin male connector
B	Yellow LED	1	Brown, +V
C	Green LED	2	White, IN/OUT
D	M3 Fixing holes for sensor mounting	3	Blue, -V
E	Sensing window	4	Black, OUT/IO-Link
F	2 m, 4 wire PVC Ø 3.3 mm cable		

Sensing

Detection



Set Point 1 (SP1)	<ul style="list-style-type: none"> • 20 ... 125 Factory settings: 100 (Approx. 100 mm @ Reference target 90% reflection)	
Set Point 2 (SP2)	<ul style="list-style-type: none"> • 20 ... 125 Factory settings: 20 (Approx. 20 mm @ Reference target 90% reflection)	
Switching logic	<ul style="list-style-type: none"> • High active • Low active Factory settings: High active	
Switching mode	SSC1 <ul style="list-style-type: none"> • Deactivated • Single point mode • Two point mode • Windows mode • FGS mode Factory settings: Single point mode	SSC2 <ul style="list-style-type: none"> • Deactivated • Single point mode • Two point mode • Windows mode • FGS mode Factory settings: Deactivated
Rated operating distance (S_n)	≤ 100 mm	Reference target, white paper with 90 % reflectivity, Size 200x200 mm
Maximum detection distance Precise mode	≤ 100 mm	White object 90% reflection
	≤ 100 mm	Grey object 18% reflection
	≤ 100 mm	Black object 6% reflection
Cutoff distance	20...150 mm Factory settings: 150 mm Measured distance beyond cut off distance, will be truncated to cut off distance. Cut off distance value will also be used when an object cannot be detected.	
Sensitivity control (selectable between)	<ul style="list-style-type: none"> • IO-Link Adjustment (SSC1) • Teach-button (SSC1) Factory settings: Teach-button	
Sensitivity adjustment	20 mm ... 125 mm	Teach-button
Blind zone	≤ 15 mm	White object 90% reflection
	≤ 17.5 mm	Grey object 18% reflection
	≤ 20 mm	Black object 6% reflection
Light source / Light type	650 nm / Red laser modulated, class 1	
Typical lifetime Laser	> 50 000 h	
Detection angle	± 0.4° Fast mode, ± 0.5° Precise mode @ 50 mm	
Light spot size	Ø 1.0 mm @ 300 mm (1/e ²)	
Emitter beam angle	± 0.01°	
Adjustable distance	20 ... 125 mm Factory settings: SP1 100 and SP2 20	White object 90% reflection
	20 ... 125 mm Factory settings: SP1 100 and SP2 20	Grey object 18% reflection
	20 ... 125 mm Factory settings: SP1 100 and SP2 20	Black object 6% reflection
Hysteresis (H)	Adjustable by IO-Link <ul style="list-style-type: none"> • Manual 1.0 mm ... 125.0 mm • Robust automatic • Fine automatic Factory settings: Fine automatic	
Detection filter	This function can increase the immunity towards unstable targets and electromagnetic disturbances: Value can be set from 1 to 255. Factory settings: 1 (1 is max. operating frequency and 255 is min. operating frequency)	

Mutual Inteferece Protection	<ul style="list-style-type: none"> • MIP Off • One channel • 2 channels - CH A • 2 channels - CH B • 3 channels - CH A • 3 channels - CH B • 3 channels - CH C 	Factory settings: MIP Off
-------------------------------------	---	----------------------------------

Application functions

Selectable dedicated applications	<ul style="list-style-type: none"> • No application • Dual Detection • Pattern Recognition • Speed and Length • Divider function • Object and Gap Monitoring 	Factory settings: No application
--	--	---

Dual Detection

A standard Foreground Suppression sensor expects to see a background within a certain specified tolerance. An object is detected if the received light's position exceeds those tolerances set for the background.

A standard Diffuse Reflective (energized) sensor detects the intensity of the received light and if it exceeds a set threshold an object is detected.

A Dual Detection sensor works as a Foreground Suppression sensor combined with a Diffuse Reflective sensor. This sensing principle evaluates both the position change as well as the light intensity of the received light.

Dual Detection	<ul style="list-style-type: none"> • Teach distance • Teach excess gain • Set Point • Hysteresis • Auto level
-----------------------	--

Pattern Recognition

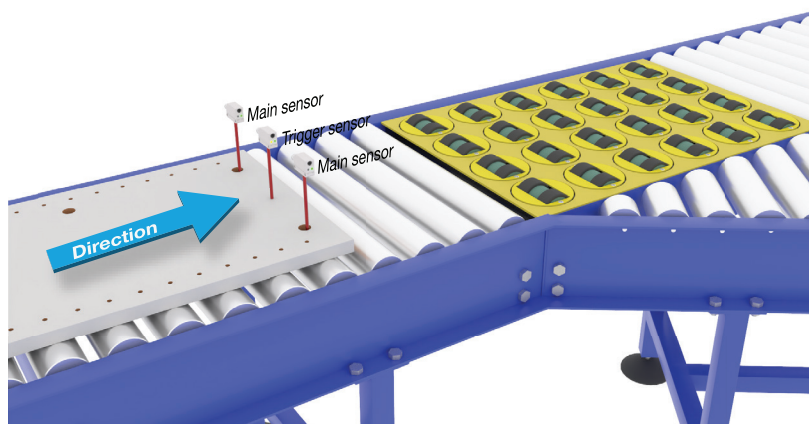

Function description	The Pattern recognition function detects a pattern (e.g. a row of holes or pins) and compares the order with a pre-teached reference pattern.
Conditions	Two sensors (Main sensor and Trigger sensor) are needed for this function.
Settings	<ul style="list-style-type: none"> The Trigger sensor has to detect the full length of the body that contains the pattern. The Main sensor has to be aimed at the e.g. holes or pins that constitute the pattern.

Speed and Length

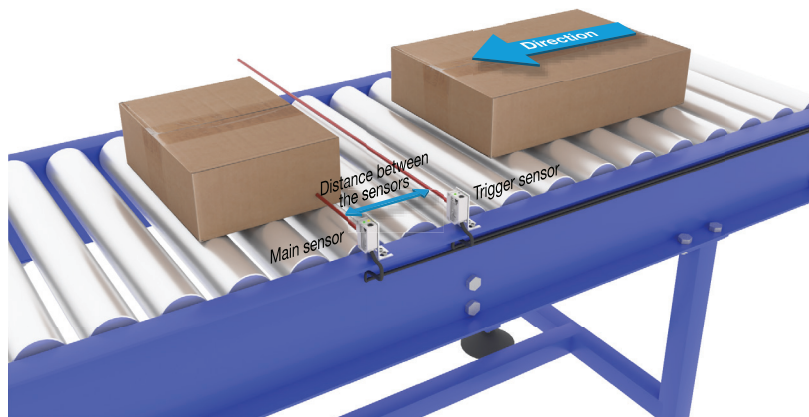

Function description	This function is designed to monitor the length of an object as well as the speed of a conveyor belt. The actual value of the length in [mm] and the speed in [mm/s] are directly available on the IO-Link master.	
Conditions	Two sensors (Main sensor and Trigger sensor) are needed for this function.	
Settings	Distance between sensors.	25 ... 150 mm Factory settings: 100 mm

Divider function

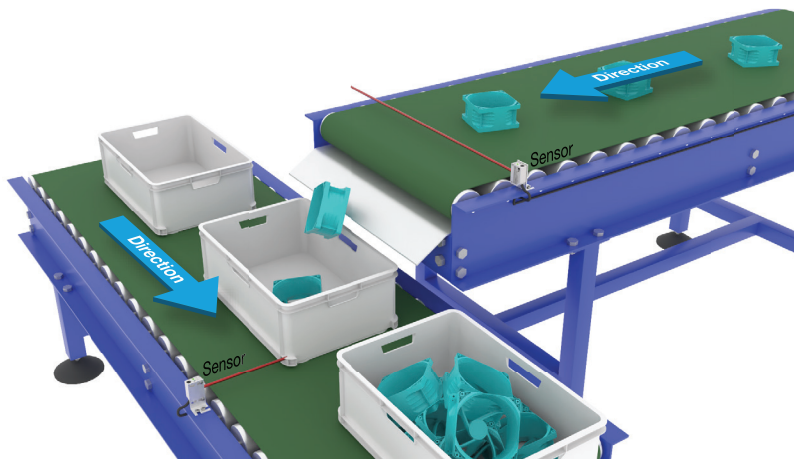

Function description	This function can be used to e.g. monitor how many items are packed into a carton box. Once the preset number is reached the sensor gives an output so the full box can be replaced.	
Conditions	Only one sensor is needed for this function.	
Settings	A counter value must be set in the sensor.	
	Counter limit.	1...60 000 Factory settings: 5

Object and Gap Monitoring

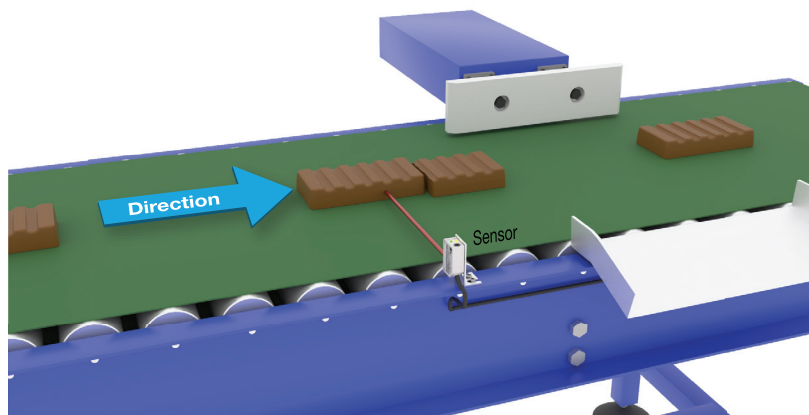

Function description	This function is designed to monitor, that the length of an object and the gap between the following object on a conveyer belt, are within certain limits.	
Conditions	Only one sensor is needed for this function.	
Settings	An acceptable minimum and maximum time [ms] must be set for both the object size and a gap size between two objects represented by the time it takes to pass the sensor.	
	Object minimum time.	10...60 000 ms Factory settings: 500 ms
	Object maximum time.	10...60 000 ms Factory settings: 10 000 ms
	Gap minimum time.	10...60 000 ms Factory settings: 500 ms
	Gap maximum time.	10...60 000 ms Factory settings: 10 000 ms
Outputs	Output 1 is active when an object is outside the set limits. Output 2 is active when the gap between two objects is outside the set limits.	

Alarm settings

Safe limits	SSC1 • 0 ... 100 % of actual SP Factory settings: 1%	SSC2 • 0 ... 100 % of actual SP Factory settings: 1%
Dust alarm	Safe limits are used for dust alarm level.	
Temperature alarm	• High threshold -50 ... +150 °C • Low threshold -50 ... +150 °C Factory settings: High value 60 °C Low value -20 °C	

Detection diagram

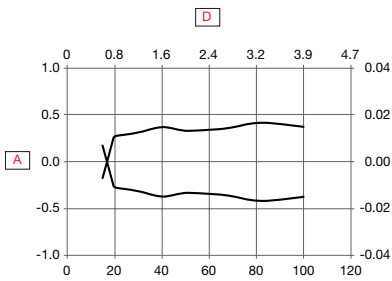

Fig. 4 Fast mode

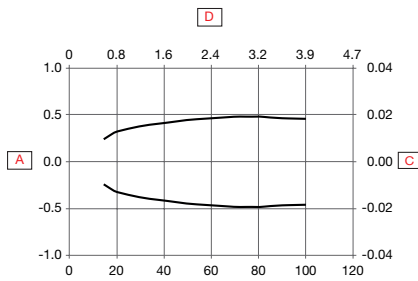
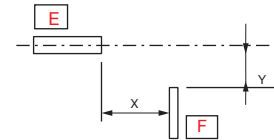

Fig. 5 Precise mode



A	Detection width (mm)	D	Sensing range (inches)
B	Sensing range (mm)	E	Sensor
C	Detection width (inches)	F	Object 25 x 25 mm, White 90%

Accuracy

Temperature drift	≤ 0.05%/°C @ 100 mm
--------------------------	---------------------

Sensing conditions

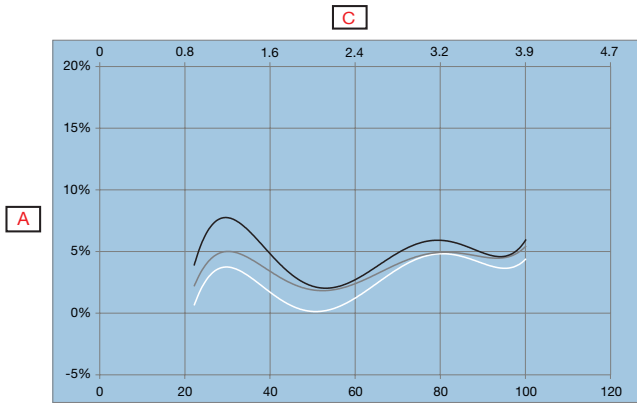

Fig. 6 Fast mode

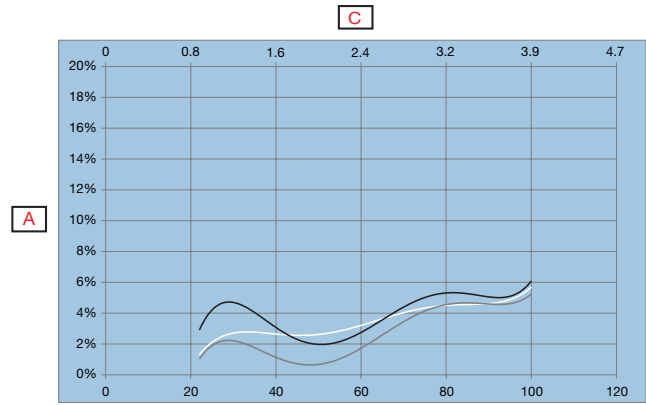





Fig. 7 Precise mode

A	Distance from background (%)		(Black on white 6%/90%)
B	Distance on white background 90% (mm)		(Grey on white 18%/90%)
C	Distance on white background 90% (inches]		(White on white 90%/90%)

Features

Power Supply

Rated operational voltage (U_B)	10 ... 30 VDC (ripple included)
Ripple (U_{rpp})	$\leq 10\%$
No load supply current (I_o)	≤ 30 mA @ U_B min. ≤ 15 mA @ U_B max.
Power-ON delay (t_v)	≤ 150 ms

Input selector

Input selector	Channel A <ul style="list-style-type: none"> • Deactivated • SSC1 • SSC2 • Dust alarm 1 • Dust alarm 2 • Temperature alarm • External input • Application functions Factory settings: SSC1	Channel B <ul style="list-style-type: none"> • Deactivated • SSC1 • SSC2 • Dust alarm 1 • Dust alarm 2 • Temperature alarm • External input • Application functions Factory settings: SSC1
----------------	--	--

Logic functions

Logic functions	Channel A + B for SO1 <ul style="list-style-type: none"> • Direct • AND • OR • X-OR • SR-FF Factory settings: Direct	Channel A + B for SO2 <ul style="list-style-type: none"> • Direct • AND • OR • X-OR • SR-FF Factory settings: Direct
-----------------	---	---

Time delays

Timer mode	For SO1 <ul style="list-style-type: none"> • Disabled • ON delay • OFF delay • ON delay and OFF delay • One-shot leading edge • One-shot trailing edge Factory settings: Disabled	For SO2 <ul style="list-style-type: none"> • Disabled • ON delay • OFF delay • ON delay and OFF delay • One-shot leading edge • One-shot trailing edge Factory settings: Disabled
Timer scale	For SO1 <ul style="list-style-type: none"> • [ms] • [s] • [min] Factory settings: ms	For SO2 <ul style="list-style-type: none"> • [ms] • [s] • [min] Factory settings: ms
Timer value	For SO1 <ul style="list-style-type: none"> • 0 ... 32 767 Factory settings: 0	For SO2 <ul style="list-style-type: none"> • 0 ... 32 767 Factory settings: 0



Outputs

Sensor output	For SO1 Pin 4 Black wire <ul style="list-style-type: none"> • Disabled output • NPN • PNP • Push-Pull Factory settings: PNP	For SO2 Pin 2 White wire <ul style="list-style-type: none"> • Disabled output • NPN • PNP • Push-Pull • External input, active high • External input, active low • External teach (Teach-in) Factory settings: PNP
Output Inverter	For SO1 Pin 4 Black wire <ul style="list-style-type: none"> • N.O. • N.C. Factory settings: N.O.	For SO2 Pin 2 White wire <ul style="list-style-type: none"> • N.O. • N.C. Factory settings: N.C.
Rated operational current (I_o)	$\leq 100\text{mA}$ (continuous) pr. output $100\text{ mA @ } 100\text{ nF Load}$ (Short-time) pr. output	
OFF-state current (I_o)	$\leq 50\ \mu\text{A}$	
Minimum operational current (I_m)	$> 0,5\ \text{mA}$	
Voltage drop (U_d)	$\leq 1.0\ \text{VDC @ } 100\ \text{mA}$	
Protection	Short circuit, reverse polarity, transients	
Utilization category	DC-12	Control of resistive loads and solid-state loads with optical isolation
	DC-13	Control of electromagnets
Capacitive load	$100\ \text{nF @ } 100\ \text{mA}, 24\ \text{VDC}$	

Operation diagram

For default factory sensor

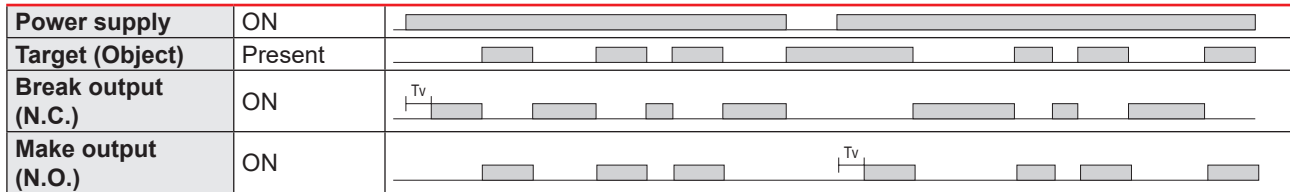
T_v = Power-ON delay



Response times

Fast mode

	Nominal detection speed		Max. detection speed	
Operating frequency (f)	≤ 800 Hz		≤ 1 kHz	
Response times	≤ 625 μs	OFF-ON (t_{ON})	≤ 0.5 ms	OFF-ON (t_{ON})
	≤ 625 μs	ON-OFF (t_{OFF})	≤ 0.5 ms	ON-OFF (t_{OFF})

Precise mode

	Nominal detection speed		Max. detection speed	
Operating frequency (f)	≤ 350 Hz		≤ 450 Hz	
Response times	≤ 1.4 ms	OFF-ON (t_{ON})	≤ 1.1 ms	OFF-ON (t_{ON})
	≤ 1.4 ms	ON-OFF (t_{OFF})	≤ 1.1 ms	ON-OFF (t_{OFF})



Indication

Green LED	Yellow LED	Power	Function
SIO and IO-Link mode			
● ON	● ON	ON	ON (stable)* SSC1
● ON	OFF	ON	OFF (stable)* SSC1
OFF	● ON	ON	ON (Not stable) SSC1
OFF	OFF	OFF	OFF (Not stable) SSC1
● Flashing 1 Hz 10% dutycycle	-	ON	Connected via IO-Link
-	● Flashing 10 Hz 50% dutycycle	ON	Output short-circuit
-	● Flashing 0.5...20 Hz 50% dutycycle	ON	Timer triggered indication
IO-Link mode only			
● Flashing 1 HZ ON 900 ms OFF 100 ms	-	-	Sensor is in IO-Link mode and SSC1 is stable
● Flashing 1 HZ ON 100 ms OFF 900 ms	-	-	Sensor is in IO-Link mode and SSC1 is not stable
● ● Flashing 2 Hz 50% dutycycle		ON	Find my sensor

*See operation diagram

LED indication

LED indication selection	<ul style="list-style-type: none"> • LED indication inactive • LED indication active • Find my sensor <p>Factory settings: LED indication active</p>
---------------------------------	--

Environmental

Ambient temperature	-25°... +50°C (-13°... +122°F)	Operating ¹⁾
	-40° ... +70°C (-40° ... +158°F)	Storage ¹⁾
Ambient humidity range	35% ... 95%	Operating ²⁾
	35% ... 95%	Storage ²⁾
Ambient light	≤ 5 000 lux	@ 3000 ... 3200 °K
Vibration	10 ...150 Hz, 1.0 mm/15 g	EN 60068-2-6
Shock	30 g _n / 11 ms, 3 pos, 3 neg per axis	EN60068-2-27
Drop test	2 x 1 m and 100 x 0.5 m	EN 60068-2-31
Rated insulation voltage (U_i)	50 VDC	
Dielectric insulation voltage	≥ 500 VAC rms	50/60 Hz for 1 min.
Rated impulse withstand voltage	>1 kV (with 500 Ω)	1.2/50 μs
Pollution degree	3	IEC60664, 60664A; EN60947-1
Overvoltage category	III	IEC60664; EN60947-1
Degree of protection	IP67, IP68 @ 2 m and 20 h	IEC60539; EN60947-1
	IP69K	DIN 40050-9
NEMA Enclosure Types	1, 2, 4, 4x, 5, 6, 6P	NEMA 250

¹⁾ Do not bend the cable in temperatures below -10°C

²⁾ With no icing or condensation

EMC

Electrostatic discharge immunity test	± 8 kV @ air discharge or ± 4 kV @ contact discharge	IEC 61000-4-2; EN60947-1
Electromagnetic field immunity	10 V/m	IEC 61000-4-3; EN60947-1
Fast transient immunity	±2 kV / 5 kHz	IEC 61000-4-4; EN60947-1
Wire-conducted noise	10 Vrms	IEC 61000-4-6; EN60947-1
Power frequency magnetic field immunity test	Continuous: >30 A/m, 28 μ tesla Short-time: >300 A/m, 280 μ tesla	IEC 61000-4-8; EN60947-1

Diagnostic parameters

Function	Unit	Range
Sensor Diagnostics		
Frontend Failure	0	0 or 1
Memory Failure	0	0 or 1
Temperature Diagnostics		
Current temperature	[°C]	-50 ... +150
Maximum temperature - All time high	[°C]	-50 ... +150
Minimum temperature - All time low	[°C]	-50 ... +150
Maximum temperature - Since last power-up	[°C]	-50 ... +150
Minimum temperature - Since last power-up	[°C]	-50 ... +150
Minutes above Maximum Temperature	[min]	0 ... 2 147 483 647
Minutes below Minimum Temperature	[min]	0 ... 2 147 483 647
Operating Diagnostic		
Operating Hours	[h]	0 ... 2 147 483 647
Number of Power Cycles	[cycles]	0 ... 2 147 483 647
Detection counter SSC1	[cycles]	0 ... 2 147 483 647
Maintenance event counter	[cycles]	0 ... 2 147 483 647
Download counter	[counts]	0 ...65 536
Quality of Teach	-	0 ... 255%
Quality of Run	-	0 ... 255%
Excess gain		0.00 ... 1 000.00
Dual Detection		
- Distance match %	[%]	0 ... 100
- Excess gain match %	[%]	0 ... 100
- Match %	[%]	0 ... 100
- Background detected	0 = No background detected 1 = Background detected Factory settings: 0	
Error Count	[counts]	0 ...65 536
Device Status	0 = Device is operating properly 1 = Maintenance required 2 = Out-of-specification 3 = Functional-Check 4 = Failure Factory settings: 0	

Events Configuration

Events	Factory default setting
Maintenance Event	Inactive
Temperature fault event	Inactive
Temperature over-run	Inactive
Temperature under-run	Inactive
Short circuit	Inactive

 Observation menu

Process Data	Factory default setting
Analogue value	Analogue value Inactive
	Analogue value normal Factory settings
	Analogue value as Object Length
	Analogue value as Object Speed
	Analogue value as Counter value
	Analogue value as Dual Detection
Excess gain	Active
SO1, Switching output 1	Active
SO2, Switching output 2	Active
SSC1, Sensor switching channel 1	Inactive
SSC2, Sensor switching channel 2	Inactive
DA1, Dust alarm SSC1	Inactive
DA2, Dust alarm SSC2	Inactive
TA, Temperature alarm	Inactive
SC, Short circuit	Inactive
AFO1, Application functions output 1	Inactive

Process data structure

4 Bytes, Analogue value 16 ... 31 (16 bit)

Byte 0	31	30	29	28	27	26	25	24
	MSB	-	-	-	-	-	-	-
Byte 1	23	22	21	20	19	18	17	16
	-	-	-	-	-	-	-	LSB
Byte 2	15	14	13	12	11	10	9	8
	-	-	SC	TA	DA2	DA1	SSC2	SSC1
Byte 3	7	6	5	4	3	2	1	0
	AFO1	-	-	-	-	-	SO2	SO1

Mechanics/electronics

Connection

Cable	2 m, 4-wire 4 x 0.14 mm ² , Ø = 3.3 mm, PVC, Black
Plug	M8, 4-pin, male

Wiring

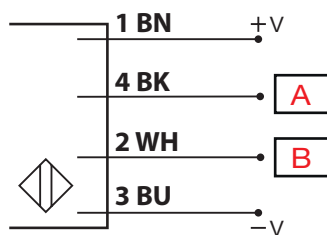

BN	BK	WH	BU	A	B
Brown	Black	White	Blue	OUT/IO-Link	IN/OUT

Housing

Body	Stainless steel, AISI316L	
Front glass	PMMA coated, Red	
Teach-button	FKM	Fluoroelastomer
Indication	PES, Transparent	Polyethersulfone
Sealing	FKM	Fluoroelastomer
Cable gland	FKM	Fluoroelastomer
Dimensions	11 x 31.5 x 21 mm	
Weight	≤ 100 g	Cable version
	≤ 65 g	Plug version

Dimensions

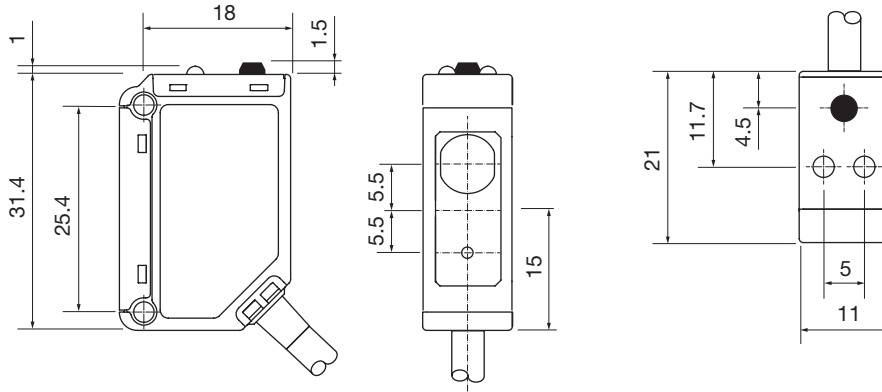

Fig. 8 Cable

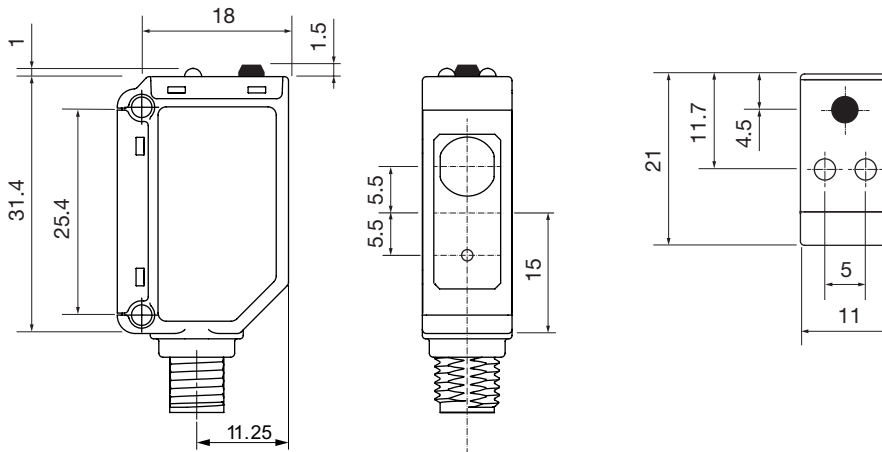



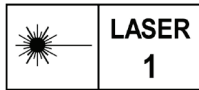

Fig. 9 Plug

Compatibility and conformity

Approvals and markings

General reference	Sensor designed according to EN60947-5-2	
MTTF_d	129.2 years	EN ISO 13849-1, SN 29500
CE-marking		
Approvals	 FDA accession number: 2220061-000	
Other Approvals		Topaz 56, Topaz AC1, Topaz MD3, Topaz CL1, Topactiv OKTO, P3-hypochloran
		Class 1 laser according to IEC 60825-1:2014 Complies with IEC / EN 60825-1:2014 and 21 CFR 1040.10 1040.11 except for deviations pursuant to Laser Notice No. 56, dated January 19, 2018

IO-Link

IO-Link revision	1.1
Transmission rate	COM2 (38.4 kbaud)
SDCI-Norm	IEC 61131-9
Profile	Smart sensor profile 2nd edition, common profile
Min. cycle time	5 ms
SIO mode	Yes
Min. master port class	A (4-pin)
Process data length	32 bit



Delivery contents and accessories



Delivery contents

- Photoelectric switch: LD30EPBR10BPxxIO
- Laser safety note
- Mounting bracket: APD30-MB1
- Packaging: Carton box

Accessories

- Mounting bracket: APD30-MB2 to be purchased separately
- Connector type: CO..54NF..W series to be purchased separately

Further information

Information	Where to find it	QR
IO-Link manual	http://cga.pub/?605166	
Mounting brackets	http://cga.pub/?6fa29a	
Connectors	http://cga.pub/?3abadc	



COPYRIGHT ©2023
Content subject to change. Download the PDF: www.gavazziautomation.com