

# LD30ETBI10BPxxIO - IO-Link



## Photoelectric Time Of Flight Sensors with IO-Link communication



### Description

The LD30ETBI10BP..IO stainless steel sensors are built with high-quality materials and designed for harsh environments.

They are designed for use in environments where high-pressure cleaning, cleaning agents and disinfectants are used on a daily basis.

The strong stainless steel (AISI316L) together with high-quality plastic materials like PEEK, PPSU, and PES sealings of FKM ensure a safe and excellent mechanical resistance.

The compact sensor design is ideally suited to confined spaces.

### Benefits

- **Long range Background suppression** TOF (Time of Flight) sensor with IO-Link with an adjustable distance of 50 to 1.000 mm, either by potentiometer or via IO-Link.
- **Infrared laser class 1** assure a reliable detection.
- **Easy customization** to specific OEM requests by use of the build in IO-Link functionalities.
- **The output can be operated** either as a standard switching output or in IO-Link mode.
- **Fully configurable via output IO-Link v 1.1.** Electrical outputs can be configured as PNP / NPN / Push-Pull / External input, normally open or normally closed.
- **Timer functions** can be set, such as ON-delay, Off-delay, and one shots.
- **Logging functions:** Temperatures, detecting counter, power cycles and operating hours.
- **Detection modes** Single point, two point and windows mode.
- **Logic functions:** AND, OR, XOR and Gated SR-FF.
- **Analogue output:** In IO-Link mode the sensor will generate 16 bit analogue process data output representing the distance to the object.

 **IO-Link**



### Applications

- The sensor has multiple detects functions e.g. in single point mode the presence or absence of objects are detected while cutting off the background information.
- The detection distance is very independent of the colour of the objects to be detected.
- The "analogue" distance from the sensor to the object is available via the IO-Link communication.

### Main functions

- The sensor can be operated in IO-Link mode once connected to an IO-Link master or in standard I/O mode.
- Adjustable parameters via IO-Link interface:
  - ▶ Sensing distance and hysteresis.
  - ▶ Sensing modes: single point or two point or window mode.
  - ▶ Timer functions, e.g.: On-delay, Off delay, One shot leading edge or trailing edge.
  - ▶ Logic functions such as: AND, OR, X-OR and SR-FF.
  - ▶ External input.
  - ▶ Logging functions: Maximum temperatures, minimum temperatures, operating hours, operating cycles, power cycles, minutes above maximum temperature, minutes below minimum temperature, etc.
  - ▶ Auto hysteresis

## References

### Product selection key

 LD30ETBI10BP  IO

 Enter the code option instead of 

Code	Option	Description
L	-	Sensing principle: Photoelectric sensor
D	-	Rectangular housing
30	-	Length of housing
E	-	Stainless steel
T	-	Top trimmer
B	-	Diffuse reflective, Background suppression
I	-	infrared light
10	-	Sensing distance: 1000 mm
B	-	<b>Selectable functions:</b> NPN, PNP, Push-Pull, External Input (only pin 2) or External teach input (only pin 2)
P	-	<b>Selectable:</b> N.O. or N.C.
<input type="checkbox"/>	A2	Cable, 2 m
	M5	Connector M8
IO	-	IO-Link version

### Type selection

Connec- tion	Housing	Code
Cable	Stainless steel	LD30ETBI10BPA2IO
Plug	Stainless steel	LD30ETBI10BPM5IO

## Structure

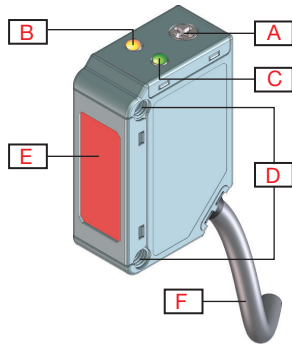

Fig. 1 Cable

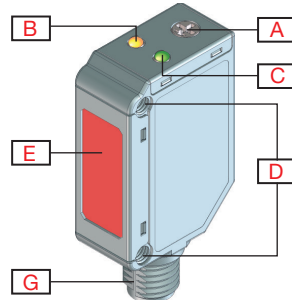

Fig. 2 Plug

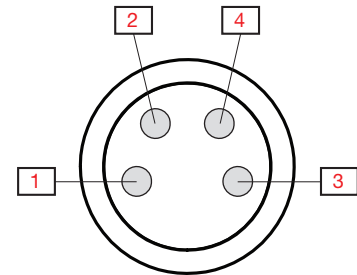
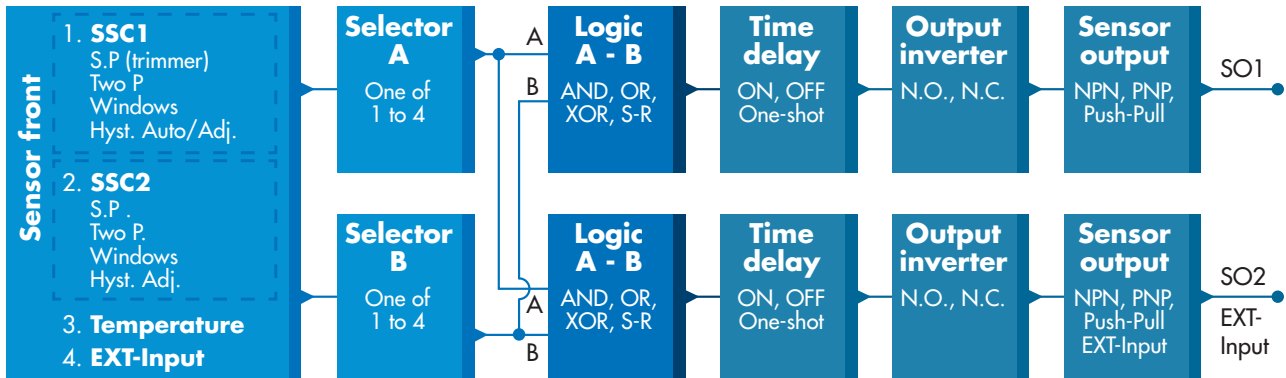

Fig. 3 "M8-plug" Pin numbers

<b>A</b>	Sensitivity adjustment (IBack trimmer)	<b>G</b>	M8, 4-pin male connector
<b>B</b>	Yellow LED	<b>1</b>	Brown
<b>C</b>	Green LED	<b>2</b>	White
<b>D</b>	M3 Fixing holes for sensor mounting	<b>3</b>	Blue
<b>E</b>	Sensing window	<b>4</b>	Black
<b>F</b>	2 m, 4 wire PVC Ø 3.3 mm cable		

# Sensing

## Detection





<b>Sensor switching channel SSC1 and SSC2</b>	<b>SSC1</b> <ul style="list-style-type: none"> <li>• Enabled</li> <li>• Disabled</li> </ul> <b>Factory settings:</b> Enabled	<b>SSC2</b> <ul style="list-style-type: none"> <li>• Enabled</li> <li>• Disabled</li> </ul> <b>Factory settings:</b> Enabled
<b>Switching mode</b>	<b>SSC1</b> <ul style="list-style-type: none"> <li>• Deactivated</li> <li>• Single point mode</li> <li>• Two point mode</li> <li>• Windows mode</li> </ul> <b>Factory settings:</b> Single point mode	<b>SSC2</b> <ul style="list-style-type: none"> <li>• Deactivated</li> <li>• Single point mode</li> <li>• Two point mode</li> <li>• Windows mode</li> </ul> <b>Factory settings:</b> Single point mode
<b>Rated operating distance (S<sub>n</sub>)</b>	1000 mm	Reference target, white paper with 90 % reflectivity, Size 200x200 mm
<b>Maximum detection distance</b>	< 1000 mm	White object 90% reflection
	< 1000 mm	Grey object 18% reflection
	< 1000 mm	Black object 6% reflection
<b>Sensitivity control</b>	Adjustable by potentiometer, external teach or by IO-Link settings <ul style="list-style-type: none"> <li>• Potentiometer disabled (SSC1)</li> <li>• Potentiometer enabled (SSC1)</li> <li>• External teach</li> </ul> <b>Factory settings:</b> Potentiometer enabled	
<b>Sensitivity adjustment</b>	50 mm ... 1000 mm	Single-turn potentiometer
	210°	Electrical adjustment
	240°	Mechanical adjustment
<b>Blind zone</b>	0 mm	White object 90% reflection
	0 mm	Grey object 18% reflection
	0 mm	Black object 6% reflection
<b>Light source</b>	940 nm	Infrared
<b>Light type</b>	Laser modulated	
<b>Laser class</b>	1	
<b>Detection angle</b>	± 1.2°	@1000 mm
<b>Light spot size</b>	Ø 18 mm	@500 mm (approximation)
<b>Emitter beam angle</b>	± 1.1°	@500 mm
<b>Adjustable distance</b>	50-1000 mm <b>Factory settings:</b> SP1 1000 and SP2 750	White object 90% reflection
	50-1000 mm <b>Factory settings:</b> SP1 1000 and SP2 750	Grey object 18% reflection
	50-1000 mm <b>Factory settings:</b> SP1 1000 and SP2 750	Black object 6% reflection
<b>Hysteresis (H)</b> <b>Manual</b> <b>Automatic</b>	Adjustable by IO-Link 5 - 2000 mm (default 50 mm) ≤10% @ S <sub>n</sub> (On all objects)	
<b>Detection filter</b>	This function can increase the immunity towards unstable targets and electromagnetic disturbances: Value can be set from 1 to 255. <b>Factory settings:</b> 1 (1 is max. operating frequency and 255 is min. operating frequency)	



**Alarm settings**

<b>Temperature alarm</b>	<ul style="list-style-type: none"> <li>• High threshold -50 to +150 °C</li> <li>• Low threshold -50 to +150 °C</li> </ul> <p><b>Factory settings:</b>                  High value 70 °C                  Low value -20 °C</p>
--------------------------	---------------------------------------------------------------------------------------------------------------------------------------------------------------------------------------------------------------------------------------

**Detection diagram**

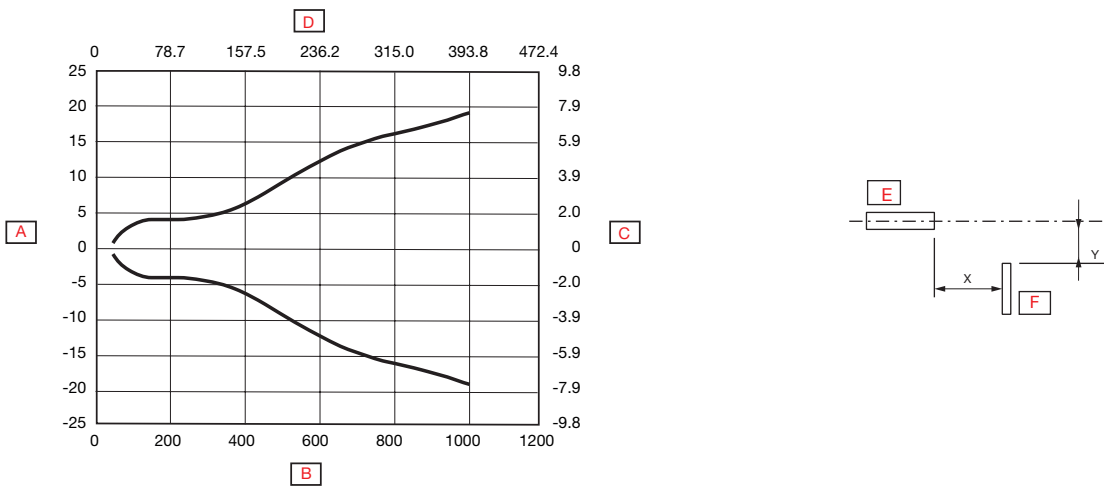

<b>A</b>	Detection width (mm)	<b>D</b>	Sensing range (inches)
<b>B</b>	Sensing range (mm)	<b>E</b>	Sensor
<b>C</b>	Detection width (inches)	<b>F</b>	Object 25 x 25 mm, White 90%

**Accuracy**

<b>Temperature drift</b>	≤ 0.05%/°C
--------------------------	------------



**Sensing conditions**

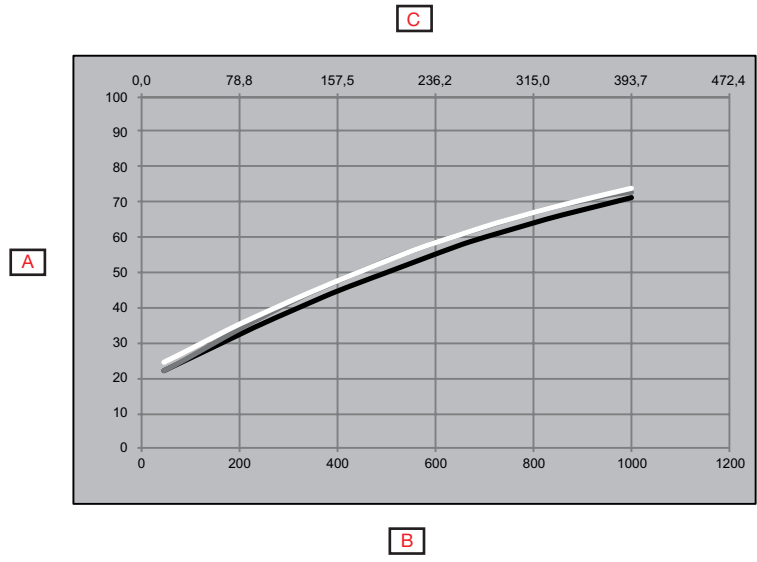

<b>A</b>	Distance from background (mm)		(Black on white 6%/90%)
<b>B</b>	White background 90% (mm)		(Grey on white 18%/90%)
<b>C</b>	White background 90% (inches)		(White on white 90%/90%)

## Features

### Power Supply

Rated operational voltage ( $U_B$ )	10 ... 30 VDC (ripple included)
Ripple ( $U_{rpp}$ )	$\leq 10\%$
No load supply current ( $I_o$ )	$\leq 25$ mA @ $U_B$ min. $\leq 12$ mA @ $U_B$ max.
Power-ON delay ( $t_v$ )	$\leq 300$ ms

### Input selector

Input selector	<b>Channel A</b> <ul style="list-style-type: none"> <li>• Deactivated</li> <li>• SSC1</li> <li>• SSC2</li> <li>• Temperature alarm</li> <li>• External input</li> </ul> <b>Factory settings: SSC1</b>	<b>Channel B</b> <ul style="list-style-type: none"> <li>• Deactivated</li> <li>• SSC1</li> <li>• SSC2</li> <li>• Temperature alarm</li> <li>• External input</li> </ul> <b>Factory settings: SSC1</b>
----------------	-------------------------------------------------------------------------------------------------------------------------------------------------------------------------------------------------------	-------------------------------------------------------------------------------------------------------------------------------------------------------------------------------------------------------

### Logic functions

Logic functions	<b>Channel A + B for SO1</b> <ul style="list-style-type: none"> <li>• Direct</li> <li>• AND</li> <li>• OR</li> <li>• X-OR</li> <li>• SR-FF</li> </ul> <b>Factory settings: Direct</b>	<b>Channel A + B for SO2</b> <ul style="list-style-type: none"> <li>• Direct</li> <li>• AND</li> <li>• OR</li> <li>• X-OR</li> <li>• SR-FF</li> </ul> <b>Factory settings: Direct</b>
-----------------	---------------------------------------------------------------------------------------------------------------------------------------------------------------------------------------	---------------------------------------------------------------------------------------------------------------------------------------------------------------------------------------

### Time delays

Timer mode	<b>For SO1</b> <ul style="list-style-type: none"> <li>• Disabled</li> <li>• Power-ON delay</li> <li>• Power-OFF delay</li> <li>• Power-ON delay and Power-OFF delay</li> <li>• One-shot leading edge</li> <li>• One-shot trailing edge</li> </ul> <b>Factory settings: Disabled</b>	<b>For SO2</b> <ul style="list-style-type: none"> <li>• Disabled</li> <li>• Power-ON delay</li> <li>• Power-OFF delay</li> <li>• Power-ON delay and Power-OFF delay</li> <li>• One-shot leading edge</li> <li>• One-shot trailing edge</li> </ul> <b>Factory settings: Disabled</b>
Timer scale	<b>For SO1</b> <ul style="list-style-type: none"> <li>• [ms]</li> <li>• [s]</li> <li>• [min]</li> </ul> <b>Factory settings: ms</b>	<b>For SO2</b> <ul style="list-style-type: none"> <li>• [ms]</li> <li>• [s]</li> <li>• [min]</li> </ul> <b>Factory settings: ms</b>
Timer value	<b>For SO1</b> <ul style="list-style-type: none"> <li>• 0 ... 32 767</li> </ul> <b>Factory settings: 0</b>	<b>For SO2</b> <ul style="list-style-type: none"> <li>• 0 ... 32 767</li> </ul> <b>Factory settings: 0</b>



### Output Inverter

Output Inverter	<b>For SO1 Pin 4 Black wire:</b> <ul style="list-style-type: none"> <li>• N.O.</li> <li>• N.C.</li> </ul> <b>Factory settings: N.O.</b>	<b>For SO2 Pin 2 White wire:</b> <ul style="list-style-type: none"> <li>• N.O.</li> <li>• N.C.</li> </ul> <b>Factory settings: N.C.</b>
-----------------	-----------------------------------------------------------------------------------------------------------------------------------------	-----------------------------------------------------------------------------------------------------------------------------------------

### Sensor Output

Switching Output Stage SO1 and SO2	<b>For SO1 Pin 4 Black wire:</b> <ul style="list-style-type: none"> <li>• NPN</li> <li>• PNP</li> <li>• Push-Pull</li> </ul> <b>Factory settings: PNP</b>	<b>For SO2 Pin 2 White wire:</b> <ul style="list-style-type: none"> <li>• NPN</li> <li>• PNP</li> <li>• Push-Pull</li> <li>• External input, active high</li> <li>• External input, active low</li> <li>• External teach</li> </ul> <b>Factory settings: PNP</b>
------------------------------------	-----------------------------------------------------------------------------------------------------------------------------------------------------------	------------------------------------------------------------------------------------------------------------------------------------------------------------------------------------------------------------------------------------------------------------------



### Outputs

Rated operational current ( $I_o$ )	$\leq 100$ mA from $-25 \dots 40^\circ\text{C}$ (SO1 + SO2) $50$ mA @ $\geq 40^\circ\text{C}$ (SO1 + SO2)	
OFF-state current ( $I_o$ )	$\leq 100$ $\mu\text{A}$	
Minimum operational current ( $I_m$ )	$> 0,5$ mA	
Voltage drop ( $U_d$ )	$\leq 1.0$ VDC @ $100$ mA DC	
Protection	Short circuit, reverse polarity, transients	
Utilization category	DC-12	Control of resistive loads and solid-state loads with optical isolation
	DC-13	Control of electromagnets
Capacitive load	$100$ nF @ $100$ mA	

### Operation diagram

#### For default factory sensor

$T_v$  = Power-ON delay

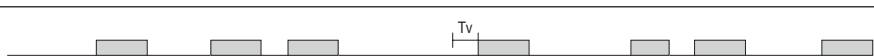
Power supply	ON	
Target (Object)	Present	
Break output (N.C.)	ON	
Make output (N.O.)	ON	

### Response times

Operating frequency (f)	$\leq 5$ Hz	
Response times	$\leq 100$ ms	OFF-ON ( $t_{ON}$ )
	$\leq 100$ ms	ON-OFF ( $t_{ON}$ )

**Indication**

Green LED	Yellow LED	Power	Function
<b>SIO and IO-Link mode</b>			
ON	ON	ON	ON (stable)* SSC1
ON	OFF	ON	OFF (stable)* SSC1
OFF	ON	-	ON (Not stable) SSC1
OFF	OFF	-	OFF (Not stable) SSC1
-	Flashing 10Hz 50% dutycycle	ON	Output short-circuit
-	Flashing (0.5...20Hz)	ON	Timer indication
<b>SIO mode only</b>			
-	Flashing 1 HZ ON 100 mS OFF 900 mS	ON	External teach by wire. Only for single point mode
-	Flashing 1 HZ ON 900 mS OFF 100 mS	ON	Teach time window (3 - 6 sec)
-	Flashing 10 HZ ON 50 mS OFF 50 mS Flashing for 2 sec	ON	Teach time out (12 sec)
-	Flashing 2 HZ ON 250 mS OFF 250 mS Flashing for 2 sec	ON	Teach successful
<b>IO-Link mode only</b>			
Flashing 1 HZ ON 900 mS OFF 100 mS	-	ON	Sensor is in IO-Link mode
Flashing 2Hz 50% dutycycle		ON	Find my sensor

\*See operation diagram

**LED indication**

<b>LED indications</b>	<ul style="list-style-type: none"> <li>• LED Indication disabled</li> <li>• LED Indication enabled</li> <li>• Find my sensor</li> </ul> <p><b>Factory settings:</b> LED Indication enabled</p>
------------------------	------------------------------------------------------------------------------------------------------------------------------------------------------------------------------------------------

**Environmental**

<b>Ambient temperature</b>	-25°... +50°C (-13°... +122°F)	Operating <sup>1)</sup>
	-40° ... +70°C (-40° ... +158°F)	Storage <sup>1)</sup>
<b>Ambient light</b>	≤ 50 000 lux (indirect) @ <5°	@ 3000 ... 3200 °K
	≤ 5 000 lux (direct) @ <5°	
<b>Vibration</b>	10 ...150 Hz, 1.0 mm/15 g	EN 60068-2-6
<b>Shock</b>	30 g <sub>n</sub> / 11ms, 6 pos, 6 neg per axis	EN60068-2-27
<b>Drop test</b>	2 x 1 m and 100 x 0.5 m	EN 60068-2-31
<b>Rated insulation voltage (U<sub>i</sub>)</b>	50 VDC	
<b>Dielectric insulation voltage</b>	≥ 500 VAC rms	50/60 Hz for 1 min.
<b>Rated impulse withstand voltage</b>	1 kV	1.2/50 μs
<b>Pollution degree</b>	3	EN60947-1
<b>Overvoltage category</b>	III	IEC60664; EN60947-1
<b>Degree of protection</b>	IP68 @ 2m and 20 h	IEC60539; EN60947-1
	IP69K	DIN 40050-9
<b>NEMA Enclosure Types</b>	1, 2, 4, 4x, 5, 6, 6P	NEMA 250
<b>Ambient humidity range</b>	35% ... 95%	Operating <sup>2)</sup>
	35% ... 95%	Storage <sup>2)</sup>

<sup>1)</sup> Do not bend the cable in temperatures below -10°C

<sup>2)</sup> With no icing or condensation

**EMC**

<b>Electrostatic discharge immunity test</b>	± 8 kV @ air discharge or ± 4 kV @ contact discharge	IEC 61000-4-2
<b>Radiated radio-frequency electromagnetic field immunity test (80 MHz ... 1 GHz and 1..4 GHz ... 2 GHz)</b>	10 V/m	IEC 61000-4-3
<b>Electrical fast transient/Burst immunity test</b>	±2 kV / 5 kHz using the capacitive coupling clamp	IEC 61000-4-4
<b>Conducted disturbances induced by radio-frequency fields immunity test (150 kHz ... 80 MHz)</b>	10 Vrms	IEC 61000-4-6
<b>Power frequency magnetic field immunity test</b>	30 A/m 38 μT	IEC 61000-4-8

### Diagnostic parameters

Function	Unit	Range
<b>Values stored in the sensor (Saved every hour)</b>		
Operating Hours	[h]	0 ... 2 147 483 647
Number of Power Cycles	[cycles]	0 ... 2 147 483 647
Maximum temperature - All time high	[°C]	-50 ... +150
Minimum temperature - All time low	[°C]	-50 ... +150
Detection counter SSC1	[cycles]	0 ... 2 147 483 647
Minutes above Maximum Temperature	[min]	0 ... 2 147 483 647
Minutes below Minimum Temperature	[min]	0 ... 2 147 483 647
<b>Values stored in the sensor (Saved with events)</b>		
Download counter	[counts]	0 ... 65 536
<b>Values not saved in sensor</b>		
Maximum temperature - Since last power-up	[°C]	-50 ... +150
Minimum temperature - Since last power-up	[°C]	-50 ... +150
Current temperature	[°C]	-50 ... +150

### Events Configuration

Events	Factory default setting
Temperature fault event	Inactive
Temperature over-run	Inactive
Temperature under-run	Inactive
Short circuit	Inactive

### Process data configuration

Process Data	Factory default setting
Analogue value	Active
SO1, Switching output 1	Active
SO2, Switching output 2	Active
SSC1, Sensor switching channel 1	Inactive
SSC2, Sensor switching channel 2	Inactive
TA, Temperature alarm	Inactive
SC, Short circuit	Inactive

### Process data structure

4 Bytes, Analogue value 16 ... 31 (16 bit)



Byte 0	31	30	29	28	27	26	25	24
	<b>MSB</b>	-	-	-	-	-	-	-
Byte 1	23	22	21	20	19	18	17	16
	-	-	-	-	-	-	-	<b>LSB</b>
Byte 2	15	14	13	12	11	10	9	8
	-	-	-	-	<b>SC</b>	<b>TA</b>	<b>SSC2</b>	<b>SSC1</b>
Byte 3	7	6	5	4	3	2	1	0
	-	-	-	-	-	-	<b>SO2</b>	<b>SO1</b>

## Mechanics/electronics

### Connection

<b>Cable</b>	2 m, 4-wire 4 x 0.14 mm <sup>2</sup> , Ø = 3.3 mm, PVC, Black
<b>Plug</b>	M8, 4-pin, male

### Wiring

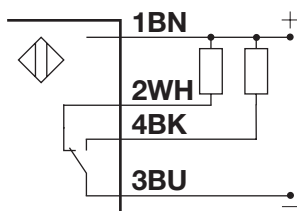

Fig. 4 NPN

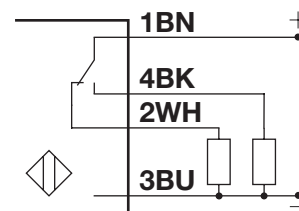

Fig. 5 PNP

BN	WH	BK	BU
Brown	White	Black	Blue

### Housing

<b>Body</b>	Stainless steel, AISI316L	
<b>Front glass</b>	PPSU, Red	
<b>Trimmer shaft</b>	PEEK, Light grey	
<b>Indication</b>	PES, Transparent	Polyethersulfone
<b>Sealing</b>	FKM	Fluoroelastomer
<b>Cable gland</b>	FKM	Fluoroelastomer
<b>Dimensions</b>	11 x 31.5 x 21 mm	
<b>Weight</b>	≤ 100 g	Cable version
	≤ 65 g	Plug version

**Dimensions**

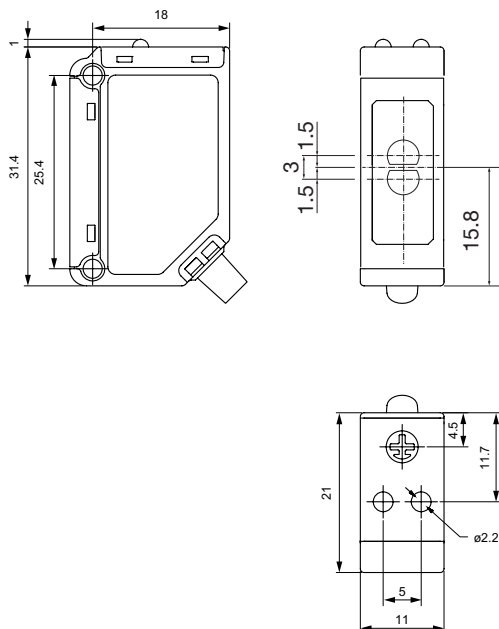



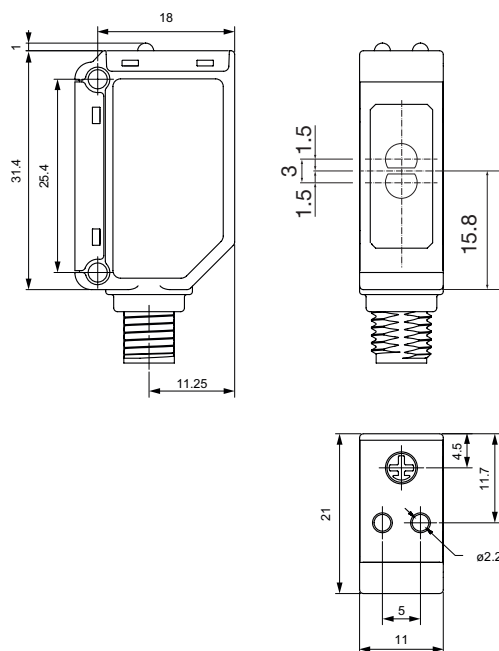

**Fig. 6 Cable**



**Fig. 7 Plug**

## Compatibility and conformity

### Approvals and markings

<b>General reference</b>	Sensor designed according to EN60947-5-2	
<b>MTTF<sub>d</sub></b>	132.3 years @ 40°C (+104°F)	ISO 13849-1, SN 29500
<b>CE-marking</b>		
<b>Approvals</b>	 (UL508 + C22.2)	
<b>Other Approvals</b>		Topax 56, Topaz AC1, Topaz MD3, Topaz CL1, Topactiv OKTO, P3-hypochloran
		Class 1 laser according to IEC 60825-1:2014 Complies with IEC / EN 60825-1:2014 and 21 CFR 1040.10 1040.11 except for deviations pursuant to Laser Notice No. 56, dated January 19, 2018

### IO-Link

<b>IO-Link revision</b>	1.1
<b>Transmission rate</b>	COM2 (38.4 kbaud)
<b>SDCI-Norm</b>	IEC 61131-9
<b>Profile</b>	Smart sensor profile 2nd edition, common profile
<b>Min. cycle time</b>	5 ms
<b>SIO mode</b>	Yes
<b>Min. master port class</b>	A (4-pin)
<b>Process data length</b>	32 bit





## Delivery contents and accessories



### Delivery contents

- Photoelectric switch: LD30ETBI10BPxxIO
- Screwdriver
- Packaging: Carton box
- Mounting bracket: APD30-MB1

### Accessories

- Mounting bracket: APD30-MB2 to be purchased separately
- Connector type: CO..54NF... series to be purchased separately

### Further information

Information	Where to find it	QR
IO-Link manual	<a href="http://www.gavazziautomation.com/images/PIM/MANUALS/ENG/MAN_LD30xxBI10_IO-Link_MUL.pdf">http://www.gavazziautomation.com/images/PIM/MANUALS/ENG/MAN_LD30xxBI10_IO-Link_MUL.pdf</a>	
Mounting brackets	<a href="http://www.productselection.net/Pdf/UK/Mounting_bracket.pdf">http://www.productselection.net/Pdf/UK/Mounting_bracket.pdf</a>	
Connectors	<a href="http://gavazziautomation.com/images/PIM/DATASHEET/ENG/CONB54NF-A2W_EN.pdf">http://gavazziautomation.com/images/PIM/DATASHEET/ENG/CONB54NF-A2W_EN.pdf</a>	

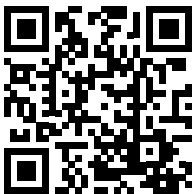

COPYRIGHT ©2019  
Content subject to change. Download the PDF: [www.productselection.net](http://www.productselection.net)