

Ultrasonic Diffuse, Analogue Output Types UA30CAD.....TI

CARLO GAVAZZI



- Cylindrical M30 PBT housing
- Sensing distance: 250-3500 mm
- Power supply: 12 (15) to 30 VDC
- Outputs: 0-10 VDC or 4-20 mA and one switching output NPN or PNP.
- Linearity error 1%
- Repeatability 0.2%
- Beam angle. $\pm 6^\circ$
- Protection: Short-circuit, reverse polarity and overvoltage
- Protection degree IP 67, Nema 4X
- 2 m cable or M12 plug



Product Description

A family of diffuse ultrasonic sensors with sensing range from 250-3500 mm with a resolution as low as 2.0 mm. The sensor contains both an analogue and a digital output. The output is either 0-10V or 4-20 mA and the digital output NPN or PNP, NO or NC which forms a windows

detection. The sensor is the ideal choice for distance measurement, level measurement, diameter measurement or loop control. Due to use of microprocessor control the digital filtering makes the sensor immune to most electromagnetic interferences.

Ordering Key

UA30CAD35NGM1TI

Ultrasonic sensor	_____
Housing style	_____
Housing size	_____
Housing material	_____
Housing length	_____
Detection principle	_____
Sensing distance	_____
Output type	_____
Output configuration	_____
Connection	_____
Teach-in	_____

Type Selection

Housing diameter	Conne- tion	Rated operating dist. (S _n)	Analog Output	Digital output NPN/PNP	Ordering no.
M30	Plug M12	250-3500 mm	4-20 mA	NPN	UA 30 CAD 35 NG M1 TI
M30	Cable	250-3500 mm	4-20 mA	NPN	UA 30 CAD 35 NG TI
M30	Plug M12	250-3500 mm	0-10 V	NPN	UA 30 CAD 35 NK M1 TI
M30	Cable	250-3500 mm	0-10 V	NPN	UA 30 CAD 35 NK TI
M30	Plug M12	250-3500 mm	4-20 mA	PNP	UA 30 CAD 35 PG M1 TI
M30	Cable	250-3500 mm	4-20 mA	PNP	UA 30 CAD 35 PG TI
M30	Plug M12	250-3500 mm	0-10 V	PNP	UA 30 CAD 35 PK M1 TI
M30	Cable	250-3500 mm	0-10 V	PNP	UA 30 CAD 35 PK TI

Specifications

Rated operating distance (S_n)	Reference target: 1 mm metal rolled finish, size 200 x 200 mm. 250 - 3500 mm	Rated operational voltage (U_B)	NG or PG versions NK or PK versions	12 to 30 VDC 15 to 30 VDC (ripple included)
Blind zone	≤ 250 mm	Ripple (U_{ripple})		≤ 5%
Repeatability	0.2%	No-load supply current (I_o)		50 mA @ U _B max
Linear Accuracy	0.5%	Output current continuous digital output (I_o)	Max. load capacity 100 nF	100 mA
Beam angle	±6°	Output current short-time digital output (I_l)	Max. load capacity 100 nF	100 mA
Sensitivity		Minimum operational current digital output (I_m)		0.5 mA
Push-button	P1 (longest setpoint) P2 (shortest setpoint)	OFF-state current digital output (I_o)		10 µA
Resolution	2 mm			
Temperature drift	0.1%/°C @ -20° to +70° C			
Temperature compensation	Yes			
Hysteresis (H)	Min. 0.5%			



Specifications (cont.)

Voltage drop digital output (U_d)	≤ 2.2 VDC @ 100 mA
Protection	
Digital output	Short-circuit, overvoltage pulses and reverse polarity
Supply	Overvoltage pulses and reverse polarity
Analogue output	Overvoltage pulses
Analog output	
NG.. or PG.. types	4 to 20 mA (Load $\leq 500 \Omega$)
NK.. or PK.. types	0 to 10 VDC (Load $\geq 3 \text{ k}\Omega$)
Carrier frequency	112 kHz
Operating frequency digital output (f)	≤ 2 Hz
Response time OFF-ON digital output (t_{ON})	≤ 250 mS
Response time ON-OFF digital output (t_{OFF})	≤ 250 mS
Power ON delay	≤ 500 mS
Output function, open collector	
By sensor type	NPN or PNP
Output switching function	One open collector transistor and one analogue output to be configured as: - Windows function with N.O or N.C. output. - Analogue output with positive or negative slope.
Indication	
Output ON	Yellow LED
Echo received	Green LED

Environment	
Installation category	III (IEC 60664/60664A; 60947-1)
Pollution degree	3 (IEC 60664/60664A; 60947-1)
Degree of protection	IP67 (IEC 60529; 60947-1) Nema 4X
Ambient temperature	
Operating	-20° to +70°C (-4° to +158°F)
Storage	-35° to +70°C (-31° to +158°F)
Vibration	10 to 55 Hz, 1.0 mm/6G. (IEC/EN 60068-2-6)
Shock	30 g / 11 mS, 3 directions (IEC/EN 60068-2-27)
Rated insulation voltage	< 500 VAC (rms)
Housing	
Material body	PBT
Material front	Epoxy-glass resin
Material back, plug	Grilamid
Material back, cable	Grilamid
Material push-button	TPE
Sealing around push-button	TPE
Material sealing front	TPE
Connection	
Cable	PVC, grey, 2 m, 4 x 0.34 mm ² , $\varnothing = 4.7$ mm M12, 4-pin (CON. 14-series)
Plug	
Tightening torque	≤ 1.5 Nm
Weight	
Cable version	160 g
Plug version	90 g
CE-marking	Yes
Approvals	cULus (UL508)

Wiring Diagram

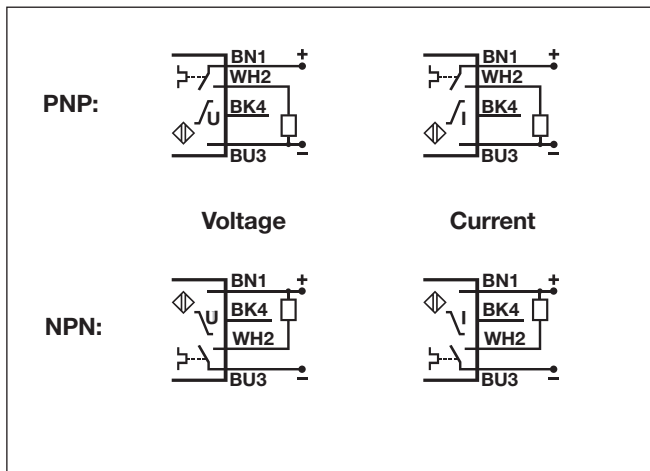

Detection Range

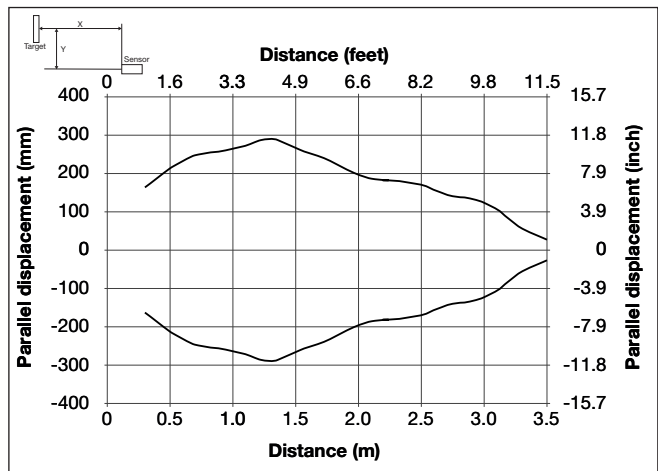

Dimensions

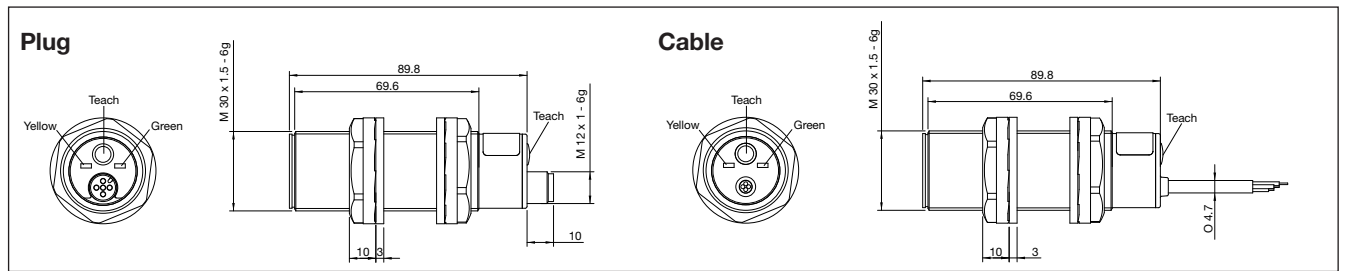

Programming setup

General set up of sensing point P1 (longest distance) and Shortest distance (P2) independent on the sensor type or function.

- 1) Mount the sensor in the selected application
- 2) Place a target in front of the sensor at the maximum required distance (P1), then press shortly on the teach-button, the Yellow LED switch Off and then On again after maximum 2 seconds. The distance (P1) is now saved in the sensor, and the target can be moved. I)
- 3) Place the target at the minimum distance requested (P2), then press shortly on the teach-button, the yellow LED turn Off then flash 5 times . The distance (P2) is now saved in the sensor and the target can be moved. II)

I) P1 can be set to a maximum exceeding the family specification for the sensor by removing the target in front of the sensor, push and hold the teach-button more than one second and the sensing distance is set at a unique distance for this sensor only. Do not use this function for an analogue output.

II) The second switch point can be set to minimum by setting the target within the blind zone close to the sensor head or by covering the sensor head with your hand while teaching P2.

Sensors with 1 digital output and one analogue output UA..CAD..PG/PK/NG or NK types

- 1) The factory setting is Normally Open N.O. for the digital output and positive slope for the analogue output.

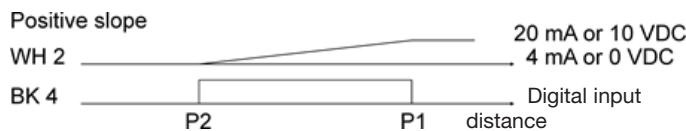

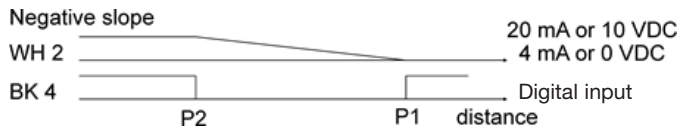

- 2) To reverse the slope to negative and reverse the N.O. output to Normally Closed N.C. Push the teach-button for 8 second until the yellow LED flash fast release the teach button and the LED will flash 5 times to acknowledge the change in function.

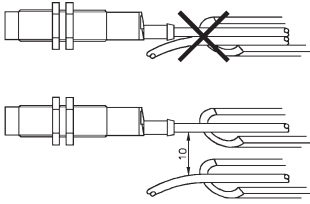
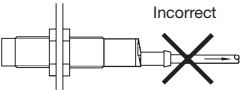

- 3) To switch back to positive slope or N.O. output, repeat step 2.

Installation Hints

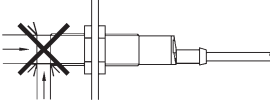
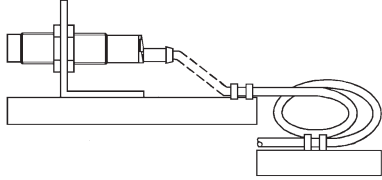
<p>To avoid interference from inductive voltage/current peaks, separate the prox. switch power cables from any other power cables, e.g. motor, contactor or solenoid cables</p> 	<p>Relief of cable strain</p> <p>Incorrect</p>  <p>Correct</p>  <p>The cable should not be pulled</p>	<p>Protection of the sensing face</p>  <p>A proximity switch should not serve as mechanical stop</p>	<p>Switch mounted on mobile carrier</p>  <p>Any repetitive flexing of the cable should be avoided</p>
---	---	---	--

Delivery Contents

- Ultrasonic sensor: UA30CAD....
- Installation instruction
- Mounting:
 - 2 x M30 Nuts
 - 2 x rubber washers
- Packaging: Carton box 35 x 107 x 173 mm

Accessories

- Connector type CONM14NF.. series