

Operating WAGO Connection Technologies

Please follow the applicable product-specific termination instructions.

PUSH-IN CAGE CLAMP®



Push-in CAGE CLAMP® terminates the following copper conductors:
solid



stranded



fine-stranded,
also with tinned
single strands



fine-stranded,
tip-bonded



fine-stranded,
with ferrule
(gastight crimped)



fine-stranded,
with pin terminal
(gastight crimped)

The universal connection with an additional advantage:

Push-in connection

Terminate solid and stranded (Class B 7 strands or less), as well as ferruled conductors, by simply pushing them in – no tools required.

Termination for all conductor types:

- Open clamping unit.
- Insert the conductor.
- Release clamp – done!

CAGE CLAMP®

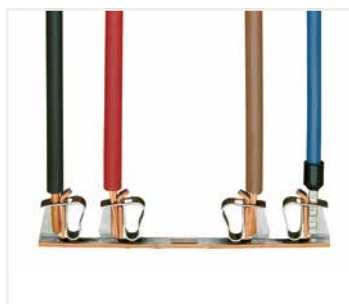

CAGE CLAMP® terminates the following copper conductors:
solid



stranded



fine-stranded,
also with tinned
single strands



fine-stranded,
tip-bonded



fine-stranded,
with ferrule
(gastight crimped)



fine-stranded,
with pin terminal
(gastight crimped)

The universal connection for solid, stranded and fine-stranded conductors

Termination:

- Open clamping unit.
- Insert the conductor.
- Release clamp – done!

Operating WAGO Connection Technologies

Please follow the applicable product-specific termination instructions.

POWER CAGE CLAMP®



POWER CAGE CLAMP terminates the following copper conductors:
solid



stranded



fine-stranded,
also with tinned
single strands



fine-stranded,
with ferrule
(gastight crimped)

The universal connection for conductors larger than 35 mm² (2 AWG)

Termination:

- Open clamp by turning a T-wrench counter-clockwise.
- Press the integrated latch to open clamping unit for hands-free wiring.
- Insert the conductor.
- A small counter-clockwise rotation closes the clamp, securing conductor.

PUSH WIRE®

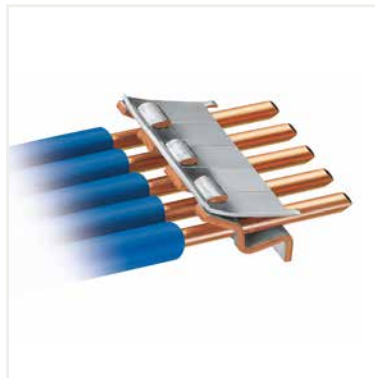
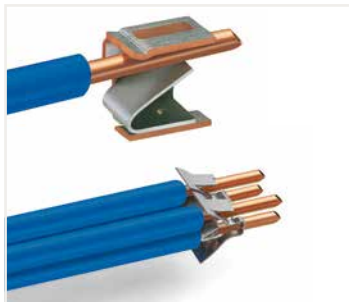

PUSH WIRE® terminates the following copper conductors:
solid

PUSH WIRE® connection for solid and stranded conductors (depending on the model used)

Termination:

Tool-free, twist-free terminations for solid and rigid stranded conductors – simply push into the unit.

Benefits of WAGO Connection Technology

Simple, Easy-to-Use Design

Front-entry wiring:

PUSH-IN CAGE CLAMP®

Push-in CAGE CLAMP® connection



Push-in CAGE CLAMP® terminates both solid and ferruled conductors by simply pushing them in.

Side-entry wiring:

CAGE CLAMP®

CAGE CLAMP® connection

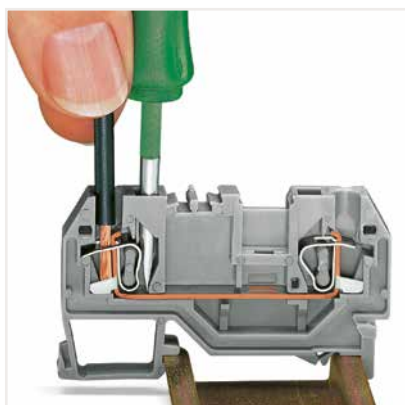

CAGE CLAMP® connection

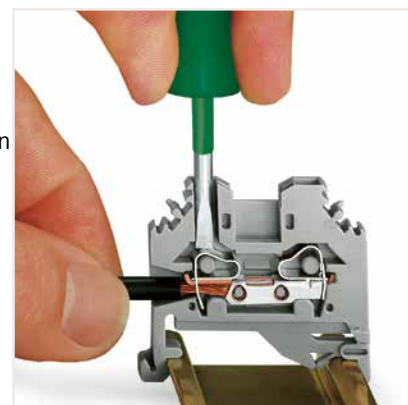

Benefits of WAGO Technology

One Conductor per Clamping Unit

Several of VDE directives mandate or recommend that only one conductor should or must be connected per clamping unit (e.g., DIN VDE 0611, Part 4, 02.91, Section 3.1.9). WAGO complies with this safety requirement, as expressed in the corresponding directives.

The technical and economic benefits of this for users include the following:

- Each conductor is clamped independently.
- Any conductor size combination per potential can be safely connected.
- Where re-wiring is required, only the conductor to be changed is removed from the clamping point – all other conductors remain safely clamped.
- The arrangement of more than two clamping units on one current bar permits potential multiplication, without jumpers or additional terminal blocks.

CAGE CLAMP® and Push-in CAGE CLAMP® terminate all copper conductors from 28 to 2 AWG (0.08–35mm²) (350 kcmil/185 mm²), or from 22 to 4 AWG (0.25–25 mm²). Splice protection is not required, but is possible.

The conductor is pressed against the current bar in the **predefined contact area**, without damage. The clamping force adjusts automatically to the conductor size. The clamp dynamically compensates for changes/movement of the conductor to eliminate the risk of a loose connection.

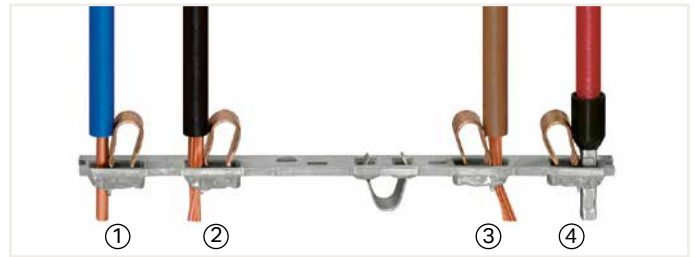

Push-in CAGE CLAMP® terminates one conductor per clamping unit.

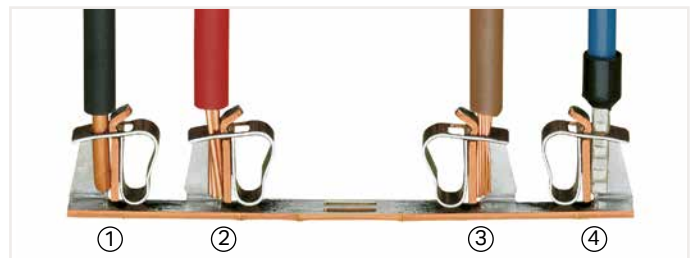

CAGE CLAMP® terminates one conductor per clamping unit

- ① Solid
- ② Stranded
- ③ Fine-stranded
- ④ Fine-stranded with ferrule (gastight crimp)

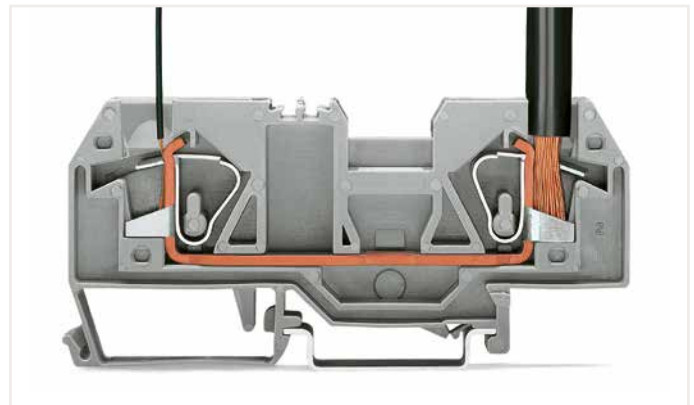

An unlikely connection demonstrates this capability: 24 AWG (0.2 mm²) conductor (left) and 6 AWG (16 mm²) conductor (right) in a 6 AWG (16 mm²) terminal block.

Benefits of WAGO Technology

Vibration- and Shock-Proof – Maintenance-Free

The **vibration-proof properties** of CAGE CLAMP® connections have been tested and successfully validated in a vibration test per IEC/EN 60068-2-6. This test involves continuous passes through a frequency band up to 2,000 Hz, at different accelerations up to 20g and different amplitudes up to 20 mm, on three axes. Additionally, international authorities have placed extremely demanding requirements on electrical installations. Railway authorities have tested electrical installations in rolling stock (IEC/EN 61373); multiple marine agencies (e.g., GL, LR and DNV) have declared that CAGE CLAMP® meets their high approval standards. It passed these tests as well.

In the **Impact Test** (IEC/EN 60068-2-27) for railway applications (IEC/EN 61373), test specimens are exposed to instant shock stresses, instead of permanent vibrations. It easily withstood stresses up to 100g on the x-, y-, and z-axis.

Maintenance-free operation results from excellent long-term stability of the electrical and mechanical properties of the clamping connection – or more precisely, the clamping unit. The voltage drop test evaluates clamping unit quality under stress such as vibration, temperature change and industrial climate, in order to verify that the contact point is gas-tight. The long-term reliability of CAGE CLAMP® technology has been demonstrated through both laboratory testing by international approval agencies and by worldwide applications.

The resulting maintenance-free operation reduces service costs, leading to greater system uptime and reliability.

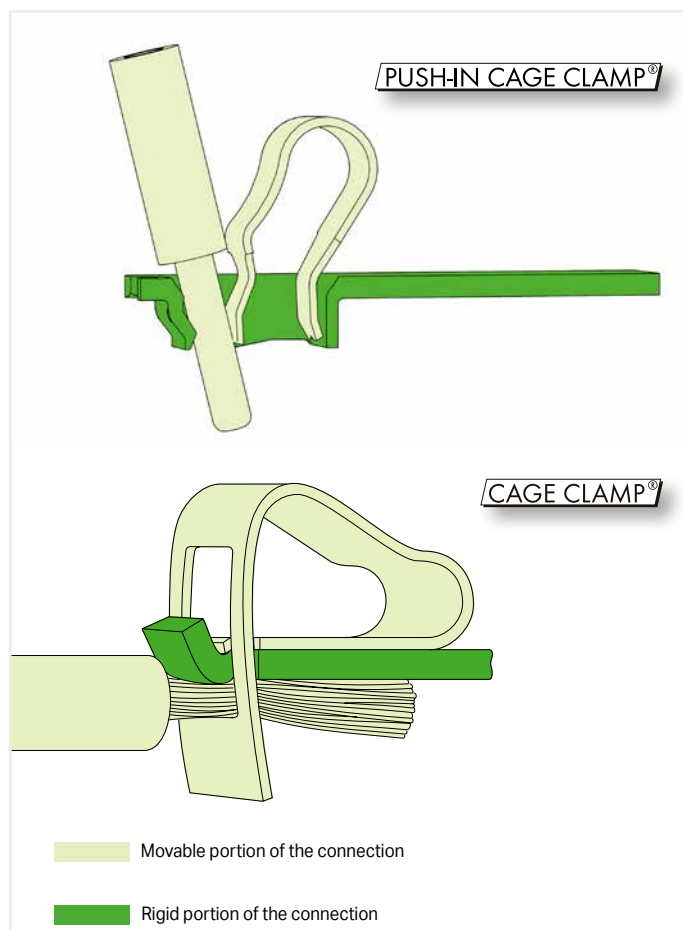

WAGO-I/O-SYSTEM vibration test

Benefits of WAGO Technology

High current-carrying capacity



Unrealistic test of a CAGE CLAMP® rail-mount terminal block, 12 AWG (4 mm²): **Increase of current without time limit.** In such an extreme test – normally, fuse devices would have long since interrupted the current – the electrical connection is undamaged.

The **short-time withstand current** is defined in standards such as IEC/EN 60947-7-1 for through rail-mount terminal blocks with a **current load of 120 A per mm² of nominal cross-section** for a duration of one second. In the case of a 185 mm² WAGO 285 Series High-Current Terminal Block, that translates to **22,200 A!**

Ground conductor terminal blocks are subjected to the "120 A per mm²" test three times for one second each.

The pass criterion for the test is the voltage drop (limit value and stability). CAGE CLAMP® and Push-in CAGE CLAMP® connections passed this test without damage or reduced functionality.

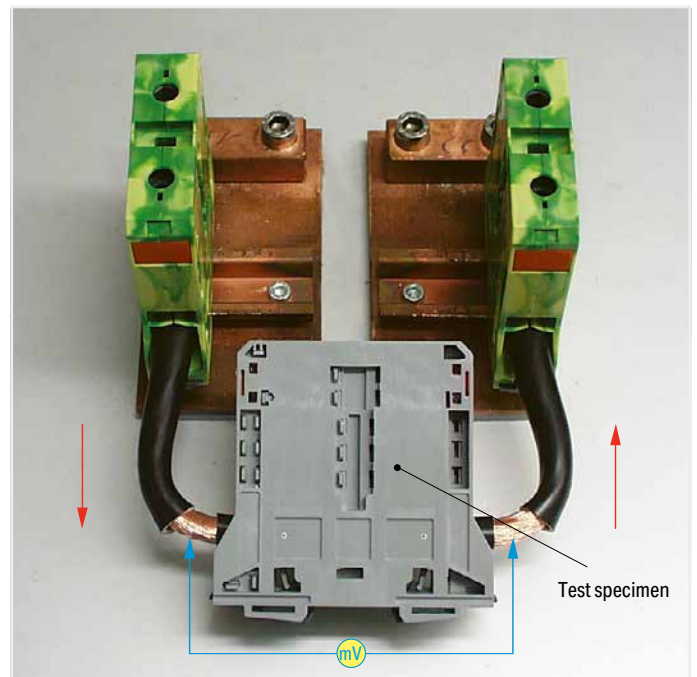

"Short-term current-carrying capacity" test arrangement

Benefits of WAGO Technology

Gastight Clamping Units – Measurable Contact Quality

For climatic tests, climatic chambers simulate standard atmospheres that could impact the long-term consistency of clamping units. All WAGO products meet requirements for the following climatic tests:

- Temperature Cycling Test per IEC/EN 60947-7-1, IEC/EN 60998-2-2
- Industrial Atmospheres per EN ISO 6988, IEC/EN 60068-2-42, IEC/EN 60068-2-60
- Salt Spray Test per IEC/EN 60068-2-11; GL, LR, DNV (Marine Applications)
- Quick Change of Temperature per IEC/EN 60068-2-14
- Damp Heat, Cyclic (12 + 12 Hour Cycle) per IEC/EN 60068-2-30, GL, LR, DNV (Marine Applications)

The long-term stability of the low contact resistance of both CAGE CLAMP® and Push-in CAGE CLAMP® results from **gas-tight** clamping units. The spring clamp (acid- and saltwater-proof CrNi spring steel) presses the connected conductor against the current bar (electrolyte copper with lead-free, pure tin coating) within a defined contact zone. The conductor is embedded into the soft tin layer with high contact pressure, securing it against corrosive infiltration.

The contact pressure exerted by CAGE CLAMP® connections is similar to screw connections.



Contact pressure

$$P \left[\frac{\text{N}}{\text{mm}^2} \right] = \frac{\text{Force } F [\text{N}]}{\text{Area } A [\text{mm}^2]}$$

Numerical example

$$\left[\frac{700 \text{ N}}{4 \text{ mm}^2} \right] = \left[\frac{70 \text{ N}}{0,4 \text{ mm}^2} \right]$$

Screw Spring

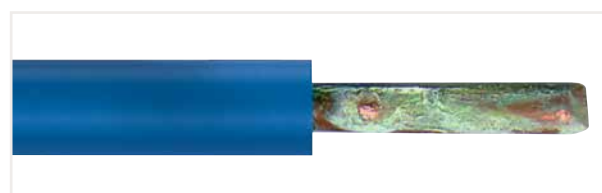

To best evaluate the quality of a clamping point, WAGO uses the following test procedures:

The **voltage drop test** evaluates clamping unit quality under stress such as vibrations, temperature change and industrial climate.

The **temperature-rise test** examines the clamping unit – including the surrounding insulation – at rated current, overcurrent and short-circuit current levels.

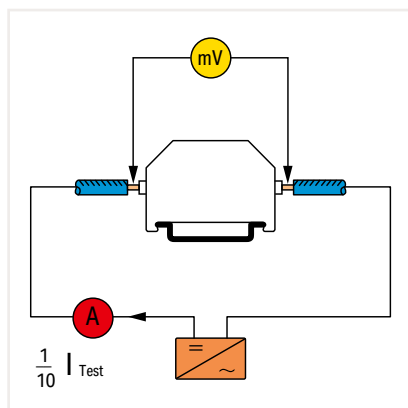

Test arrangement: "Voltage Drop Test"

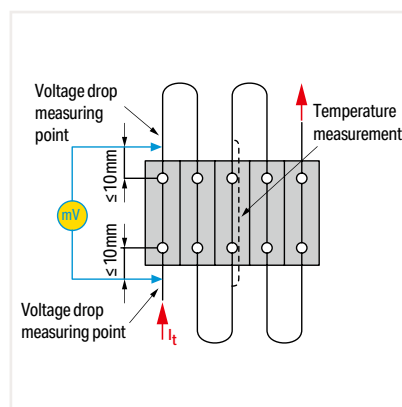

Test arrangement: "Temperature-Rise Test"

Benefits of WAGO Technology Electromagnetic Compatibility (EMC)

State-of-the-art testing equipment in our laboratory enables us to conduct the most stringent electrical, mechanical and climatic tests. In addition, our electromagnetic compatibility chamber is dedicated to testing our automation components for compliance with electromagnetic safety regulations.

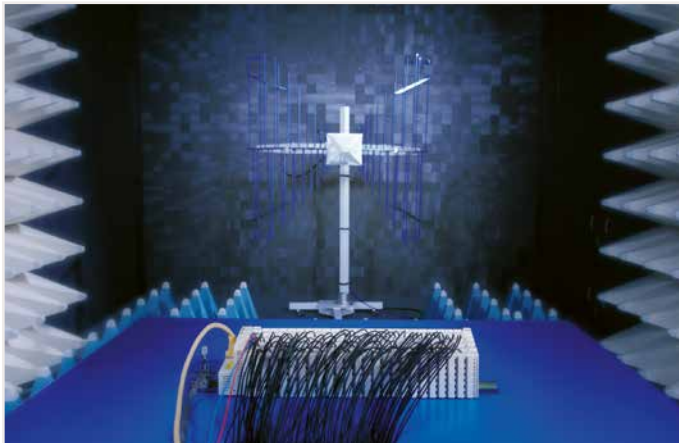

To isolate and eliminate any weak points during development in our electromagnetic compatibility laboratory, we can use bursts of up to 3 kV.

All of our automation components have to meet WAGO's requirements, which are stricter than those defined in CE specifications and the requirements as specified by the international shipping classification organizations.

Time Saved

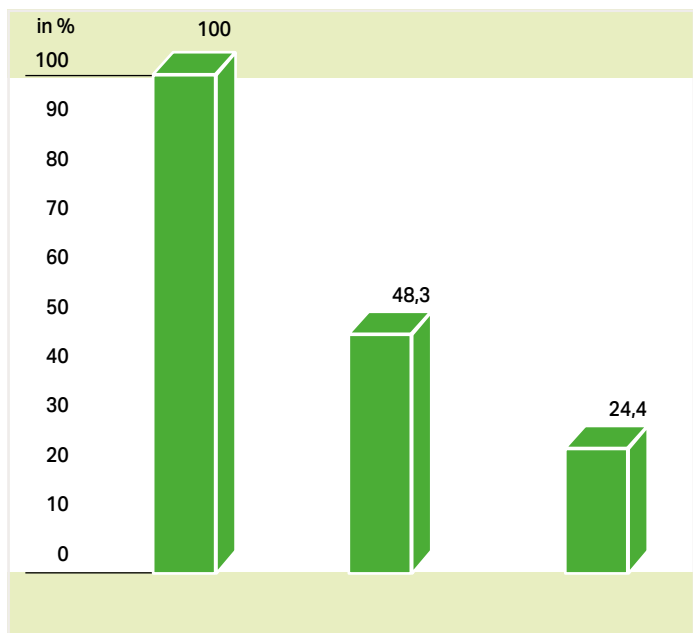

CAGE CLAMP® technology significantly reduces wiring times, which helps minimize labor costs.

Additional savings are provided via **faster commissioning** and the **elimination of service costs** due to maintenance-free connections.

Savings go further by **reducing both material and labor costs** by eliminating the need to crimp ferrules or use pin terminals prior to termination. Front-entry terminal blocks are specified for top-tier designs because they minimize both installation time and effort.

Comparison of Average Manual Wiring Times in Percentages (per MTM)

WAGO Rail-Mount Terminal Blocks TOPJOB® S; With Levers and Push-in CAGE CLAMP®; With Push-Buttons and Push-in CAGE CLAMP – 2102 to 2216 Series

Description and Installation

1

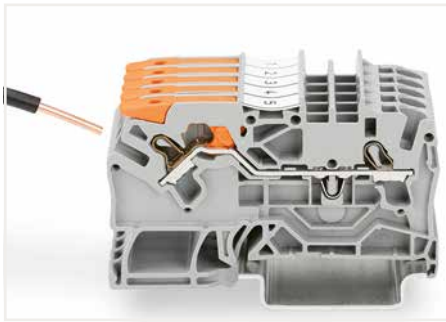

Insert solid conductors via push-in termination.

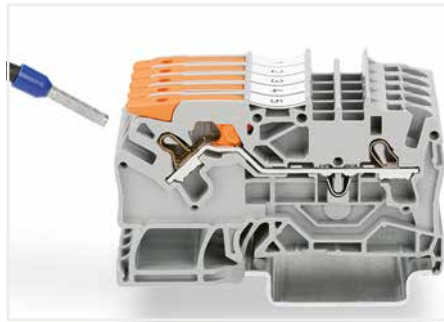

Insert fine-stranded conductors with ferrules via push-in termination.

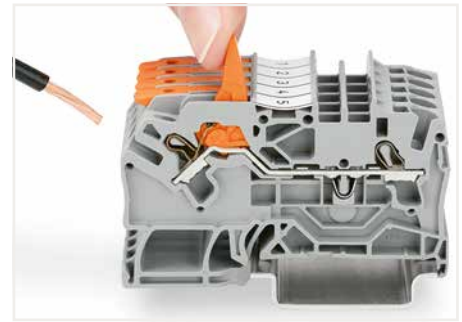

Pull the lever up until it stops, then connect the fine-stranded conductor.

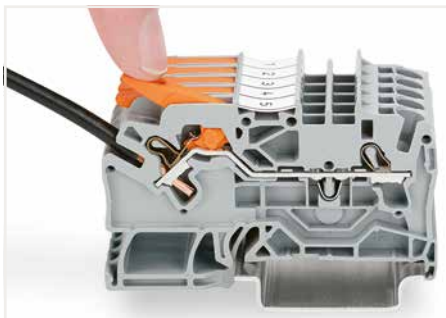

Push the lever back down – done!

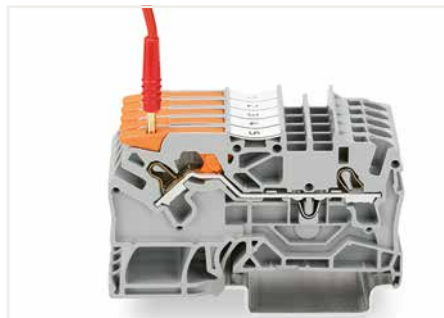

Testing with a 2 mm Ø test plug (max. 42 V).



Insert solid and ferruled conductors via push-in termination.



Insert fine-stranded conductors via operating tool.



Remove all conductors via operating tool.



Testing with a 2 mm Ø test plug (max. 42 V).



Insert a push-in type jumper bar and push down until it hits the backstop.



Commoning with step-down jumpers.



Snapping a marking strip into the marker slot.

WAGO Rail-Mount Terminal Blocks TOPJOB® S; With Push-in CAGE CLAMP®

2000 to 2016 Series

Description and Installation

1



Insert solid and ferruled conductors via push-in termination.

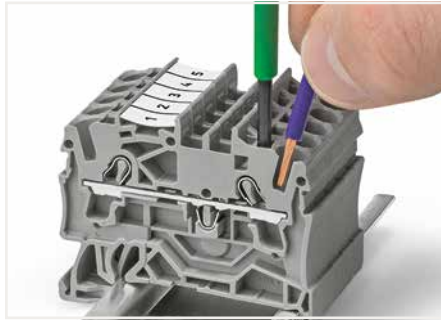

Insert fine-stranded conductors via operating tool.

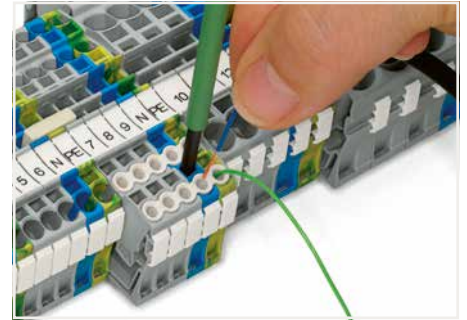

Inserting a conductor into the insulation stop.



Insert a push-in type jumper bar and push down until it hits the backstop.



Custom jumpers are created by breaking and removing jumper contacts (2000, 2001, 2002, 2004 Series).

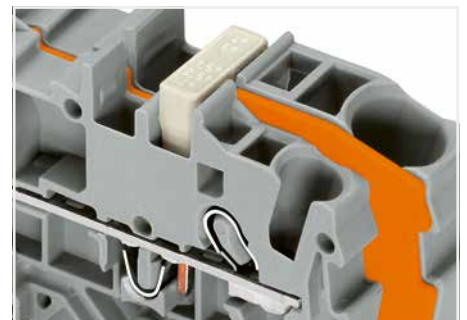

Commoning with step-down jumpers.



Test plug adapter (2009-174, CAT I) for 4 mm Ø plugs – compatible with 2000 to 2016 Series

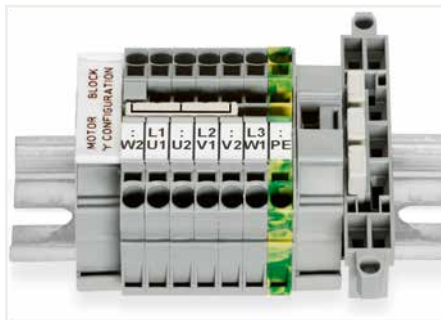

This star point jumper has been specially developed to create a "star point" and is used on motor terminal boards equipped with TOPJOB® S Rail-Mount Terminal Blocks.

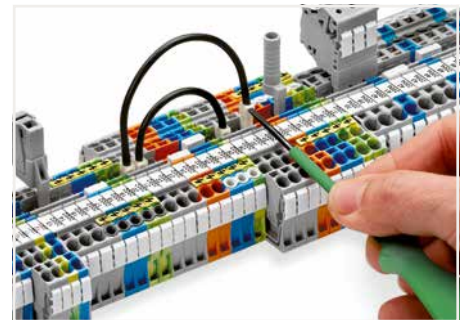

Push down the wire jumper until fully inserted. Lift the jumper with an operating tool for rewiring.



L-type test plug modules fitted in a triple-deck terminal block

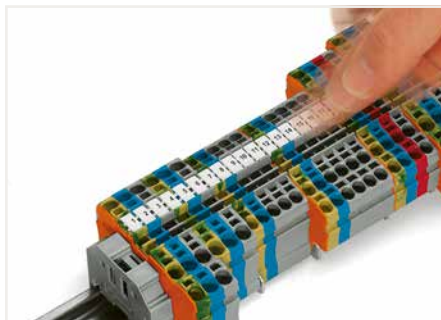

Snapping a marking strip into the marker slot.

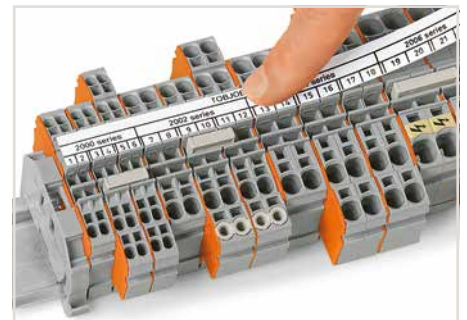

Snapping a marking strip into a marker slot.

WAGO Through/Ground/Shield Terminal Block TOPJOB® S – 2002/2102/2202 Series

2.5 (4) mm²

1

Image	Description	Color	With Push-Button Item No.	Without Push-Button Item No.	PU	Dimensions (W x H x D)	Electrical Data
2-conductor through terminal block							
	2-conductor through terminal block; with lever	gray	2102-5201	2102-1201	100	5,2 x 32,9 x 61,5 mm / 0.205 x 1.3 x 2.42 inch	800 V/8 kV/3 ①; I _n 24 A (32 A)
	2-conductor through terminal block; with lever	blue	2102-5204 ③	2102-1204 ③	100		
	2-conductor ground terminal block; with lever	green-yellow	2102-5207	2102-1207	100		
	End and intermediate plate; 0,8 mm thick	orange	2102-1292	2102-1292	25	0,8 x 33 x 61,5 mm / 0.03 x 1.3 x 2.42 inch	
	End and intermediate plate; 0,8 mm thick	gray	2102-1291	2102-1291	25		
	2-conductor through terminal block	gray ⑤	2202-1201	2002-1201 ②	100	5,2 x 32,9 x 48,5 mm / 0.205 x 1.3 x 1.91 inch	800 V/8 kV/3 ①; I _n 24 A (32 A); 600 V, 20 A ④; 600 V, 20 A ⑥
	2-conductor through terminal block	blue ⑤	2202-1204 ③	2002-1204 ②③	100		
	2-conductor through terminal block	orange ⑤		2002-1202 ②	100		
	2-conductor through terminal block	red ⑤	2202-1203	2002-1203 ②	100		
	2-conductor through terminal block	black ⑤	2202-1205	2002-1205 ②	100		
	2-conductor through terminal block	yellow ⑤		2002-1206 ②	100		
	2-conductor through terminal block	light gray	2202-1209		100		
	2-conductor ground terminal block	green-yellow ⑤	2202-1207	2002-1207 ②	100		
	2-conductor shield terminal block	white		2002-1208	100		
	End and intermediate plate; 0,8 mm thick	orange	2002-1292	2002-1292	25	0,8 x 33 x 48,5 mm / 0.03 x 1.3 x 1.91 inch	
	End and intermediate plate; 0,8 mm thick	gray	2002-1291	2002-1291	25		
	Separator plate; oversized; 2 mm thick	orange	2002-1294	2002-1294	25		
	Separator plate; oversized; 2 mm thick	gray	2002-1293	2002-1293	25		
	Separator plate Ex e/Ex i; 3 mm thick; 90 mm	orange	209-190	209-190	25		
	Separator plate Ex e/Ex i; 3 mm thick; 120 mm	orange	209-191	209-191	25		
3-conductor through terminal block							
	3-conductor through terminal block; with lever	gray	2102-5301	2102-1301	100	5,2 x 32,9 x 72,2 mm / 0.205 x 1.3 x 2.84 inch	800 V/8 kV/3 ①; I _n 24 A (30 A)
	3-conductor through terminal block; with lever	blue	2102-5304 ③	2102-1304 ③	100		
	3-conductor ground terminal block; with lever	green-yellow	2102-5307	2102-1307	100		
	End and intermediate plate; 0,8 mm thick	orange	2102-1392	2102-1392	25	0,8 x 33 x 72,2 mm / 0.03 x 1.3 x 2.84 inch	
	End and intermediate plate; 0,8 mm thick	gray	2102-1391	2102-1391	25		
	3-conductor through terminal block	gray ⑤	2202-1301	2002-1301 ②	100	5,2 x 32,9 x 59,2 mm / 0.205 x 1.3 x 2.33 inch	800 V/8 kV/3 ①; I _n 24 A (32 A); 600 V, 15 A ④; 600 V, 15 A ⑥
	3-conductor through terminal block	blue ⑤	2202-1304 ③	2002-1304 ②③	100		
	3-conductor through terminal block	orange ⑤	2202-1302	2002-1302 ②	100		
	3-conductor through terminal block	red ⑤	2202-1303	2002-1303 ②	100		
	3-conductor through terminal block	black ⑤	2202-1305	2002-1305 ②	100		
	3-conductor through terminal block	yellow ⑤	2202-1306	2002-1306 ②	100		
	3-conductor ground terminal block	green-yellow ⑤	2202-1307	2002-1307 ②	100		
	3-conductor shield terminal block	white		2002-1308	100		
		End and intermediate plate; 0,8 mm thick	orange	2002-1392	2002-1392		
End and intermediate plate; 0,8 mm thick		gray	2002-1391	2002-1391	25		
Separator plate; oversized; 2 mm thick		orange	2002-1394	2002-1394	25		
Separator plate; oversized; 2 mm thick		gray	2002-1393	2002-1393	25		
Separator plate Ex e/Ex i; 3 mm thick; 120 mm		orange	209-191	209-191	25		
Separator plate Ex e/Ex i; 3 mm thick; 120 mm		orange	209-191	209-191	25		
4-conductor through terminal block							
	4-conductor through terminal block	gray ⑤	2202-1401	2002-1401 ②	100	5,2 x 32,9 x 69,9 mm / 0.205 x 1.3 x 2.75 inch	800 V/8 kV/3 ①; I _n 24 A (32 A); 600 V, 15 A ④; 600 V, 15 A ⑥
	4-conductor through terminal block	blue ⑤	2202-1404 ③	2002-1404 ②③	100		
	4-conductor through terminal block	orange ⑤		2002-1402 ②	100		
	4-conductor through terminal block	red ⑤		2002-1403 ②	100		
	4-conductor through terminal block	black ⑤		2002-1405 ②	100		
	4-conductor through terminal block	yellow ⑤		2002-1406 ②	100		
	4-conductor through terminal block	green	2202-1401/000-001		100		
	4-conductor through terminal block	light gray	2202-1409		100		
	4-conductor ground terminal block	green-yellow ⑤	2202-1407	2002-1407 ②	100		
	4-conductor shield terminal block	white		2002-1408	100		
	End and intermediate plate; 0,8 mm thick	orange	2002-1492	2002-1492	25	0,8 x 33 x 70 mm / 0.03 x 1.3 x 2.76 inch	
	End and intermediate plate; 0,8 mm thick	gray	2002-1491	2002-1491	25		
	Separator plate; oversized; 2 mm thick	orange	2002-1494	2002-1494	25		
	Separator plate; oversized; 2 mm thick	gray	2002-1493	2002-1493	25		
	Separator plate Ex e/Ex i; 3 mm thick; 120 mm	orange	209-191	209-191	25		

Conductor range: 0.25 ... 4 mm² "s+f-st"; Push-in termination: 1 ... 4 mm² "s" and 1 ... 2.5 mm² "insulated ferrules; 12 mm"; 22 ... 14 AWG;
Strip length: 10 ... 12 mm / 0.39 ... 0.47 inch
Accessories: see pages 36 ... 38.

① 800 V = rated voltage;
8 kV = rated impulse voltage;
3 = pollution degree

Marking: WMB/WMB Inline/Marking strips

② Suitable for Ex e II applications; 550 V; 22 A
③ Suitable for Ex i applications

Suitable operating tool: see page 39