

# PyroMini

## Miniature Infrared Temperature Sensor with Optional High-Ambient Sensing Head and Touch Screen



Model shown includes optional touch screen

- Miniature sensing head and configurable electronics module
- Touch screen (optional) for temperature indication and configuration. Screen changes colour in alarm condition for maximum visibility
- High-ambient sensing head (optional) withstands up to 180°C without cooling
- Adjustable emissivity setting on all models - suitable for a wide range of target materials such as paper, plastics, food, painted surfaces, and many more
- Data logging to MicroSD Card (optional) on touch screen models
- Resistant to interference from movement of sensing head cable - ideal for mounting on robot arms
- 4 to 20 mA or RS485 Modbus outputs
- Alarm relay outputs rated 24 V DC (optional) - no need for separate trip amplifier
- Temperature ranges from -20°C to 1000°C
- Maximum, minimum, average and instantaneous readings, peak or valley hold, reflected energy compensation
- Optional mounting brackets, air purge collar, laser sighting tool and protective window
- Sensing head sealed to IP65

### GENERAL SPECIFICATIONS

#### Temperature Range

See table of Model Numbers

#### Maximum Temperature Span (-CRT models)

1020°C

#### Minimum Temperature Span (-CRT models)

100°C

#### Output

4 to 20 mA or RS485 Modbus\*

#### Field of View

See table of Model Numbers

#### Accuracy

± 1°C or 1%, whichever is greater

#### Repeatability

± 0.5°C or 0.5%, whichever is greater

#### Emissivity Setting Range

0.20 to 1.00

#### Emissivity Setting Method

-CB models: via two rotary switches in electronics box

-BB and -BRT models: via RS485

-CRT and -BRT models: via touch screen

#### Response Time, $t_{90}$

240 ms (90% response)

#### Spectral Range

8 to 14  $\mu$ m

#### Supply Voltage

24 V DC  $\pm$  5%

#### Maximum Current Draw

100 mA

#### Maximum Loop Impedance

CB and -CRT models: 900  $\Omega$  (4 to 20 mA output)

#### Alarm Relays (-CRT and -BRT models)

2 x Single Pole Changeover alarm relays rated

24 V DC, 1 A, isolated 500 V DC

\* Up to 247 sensors may be installed on a single Modbus network.

### MECHANICAL

	Sensing head	Electronics Module
<b>Construction</b>	Stainless Steel 316	Die-cast Aluminium
<b>Major Dimensions</b>	$\varnothing$ 18 x 45 mm (see diagram)	98(w) x 64(h) x 36(d) mm (see diagram)
<b>Mounting</b>	M16 x 1 mm thread	Two M4 screws for wall mounting (see diagram)

#### Cable Length (sensing head to electronics module)

1 m (standard), up to 30 m (optional)

#### Weight with 1 m Cable

390 g (approx)

#### Cable Connections

Removable screw terminal blocks (see Connections)

Conductor size: 28 AWG to 18 AWG

Suitable for cable diameters 3.0 to 6.5 mm

#### Output Cable Gland

### ENVIRONMENTAL

	Sensing head	Electronics Module (without touch screen)	Electronics Module (with touch screen)
<b>Environmental Rating</b>	IP65 (NEMA 4)	IP65 (NEMA 4)	-
<b>Ambient Temperature Range</b>	See table of Model Nos	0°C to 60°C	0°C to 60°C
<b>Relative Humidity</b>	Maximum 95% non-condensing	Maximum 95% non-condensing	Maximum 95% non-condensing
<b>CE Marked</b>	Yes	Yes	Yes
<b>RoHS Compliant</b>	Yes	Yes	Yes

### ELECTROMAGNETIC COMPATIBILITY STANDARDS:

Class	Standard	Description
<b>EMC Directive</b>	EN61326-1:2006	Electrical equipment for measurement, control and laboratory use – Industrial
<b>- Immunity</b>	IEC 61000-4-2	Electrostatic Discharge Immunity
	IEC 61000-4-3	Electromagnetic Field Immunity
	IEC 61000-4-4	Burst Immunity
	IEC 61000-4-5	Surge Immunity
	IEC 61000-4-6	Conducted RF Immunity
<b>- Emissions</b>	EN 55022A	RF Emissions Class A
	EN 55022B	RF Emissions Class B

## TOUCH SCREEN (-CRT AND -BRT MODELS)

The optional backlit touch screen interface mounted in the lid of the electronics module provides a large, bright display of the measured temperature, as well as controls allowing full configuration of the sensor. The graph view shows the history of the measured temperature.

In alarm conditions, the display changes colour to provide an immediate and obvious alarm indication. Alarm modes and levels can be configured via the touch screen.

## TOUCH SCREEN SPECIFICATIONS

<b>Touch Screen Display Format</b>	2.83" (72 mm) resistive touch TFT, 320 x 240 pixels, backlit
<b>Configurable Parameters</b>	Temperature range, temperature units, emissivity setting, reflected energy compensation, alarms, signal processing, Modbus address (-BRT models), date and time, data logging
<b>Temperature Units</b>	°C or °F configurable
<b>Temperature Resolution</b>	0.1°
<b>Alarm Configuration</b>	Two alarms with adjustable level, individually configurable as HI or LO. Alarm 2 can be set to target temperature or sensing head internal temperature
<b>Signal Processing</b>	Average, peak hold, valley hold, minimum, maximum

## EXAMPLE SCREENSHOTS



Screen shown with red background to indicate alarm condition

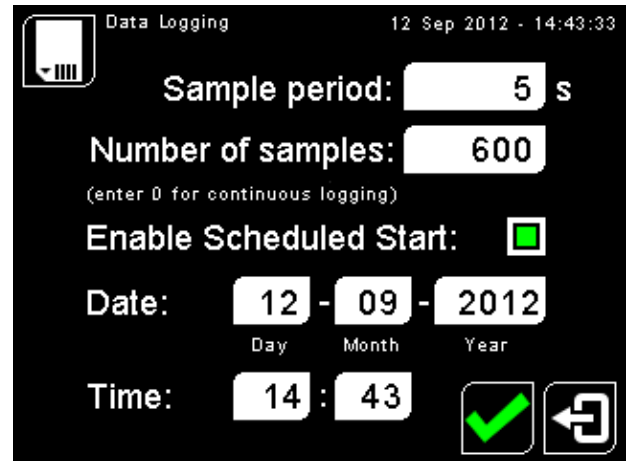
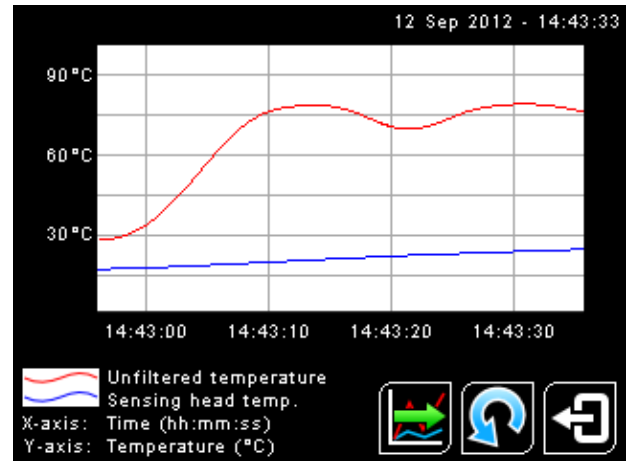

## DATA LOGGING SPECIFICATIONS

<b>Data Logging Interval</b>	1 to 86,400 seconds (1 day)
<b>MicroSD Card</b>	Max. capacity: 2 GB (not included)
<b>Internal Clock Battery</b>	1 x BR 1225 3V (not included)
<b>Variables Logged</b>	Target temperature, sensing head temperature, electronics module temperature, max, min, average, emissivity setting, reflected energy compensation temperature, alarm events
<b>File format</b>	.csv
<b>Configurable Parameters</b>	Sample period, number of samples, scheduled start date and time

## DATA LOGGING (-CRT AND -BRT MODELS)

The PyroMini can be used as a standalone data logger.

PyroMini models -CRT and -BRT include a MicroSD card slot for data logging, which can be configured via the touch screen interface. The user can select the sample rate and the number of samples to be taken and schedule the data logging to start at a certain time.

With a 2 GB card, the user can store 28.4 million readings, which provides almost 1 year's worth of data at the fastest possible sample rate of 1 per second.

Data is stored on the MicroSD card in .csv format and can be viewed and edited easily using spreadsheet software. Alarm events can also be logged to the MicroSD Card.

A MicroSD card with SD card adapter is available as an optional accessory.

The MicroSD card slot and battery holder are located on the touch screen circuit board in the lid of the PyroMini. Readings are time and date stamped using the sensor's internal clock. The clock is reset when the power is disconnected, or it will continue if the optional battery is fitted.

MODEL NUMBERS

Series	Sensing Head Operating Temperature Range	Field of View	Measurement Temperature Range	Output and Interface
PM	MA	21 151 301 CF	LT MT HT XT	CB
			CT	CRT BB BRT
	HA	201	HT XT	CB
			CT	CRT BB BRT



SENSING HEAD OPERATING TEMPERATURE RANGE

- MA 0°C to 60°C
- HA 0°C to 180°C

The High Ambient sensing head is capable of withstanding temperatures of up to 180°C without cooling. It is available with 20:1 optics.

There is no need to supply cooling air or water, and the miniature sensing head is much smaller than bulky, cooled sensors.

FIELD OF VIEW

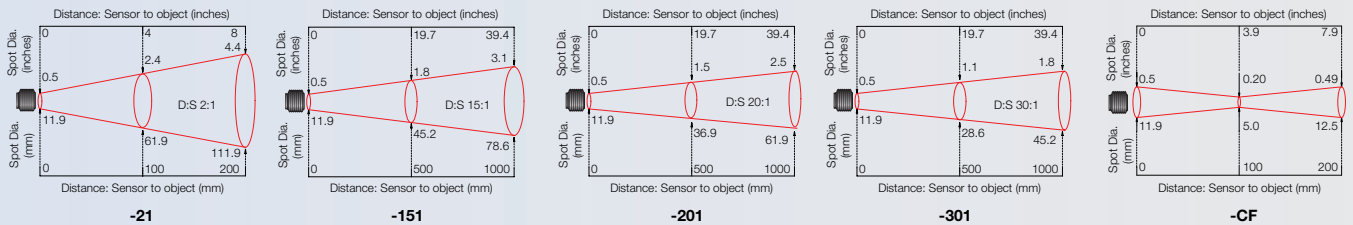

Diameter of target spot measured versus distance from sensing head - 90% energy

MEASUREMENT TEMPERATURE RANGE (°C)

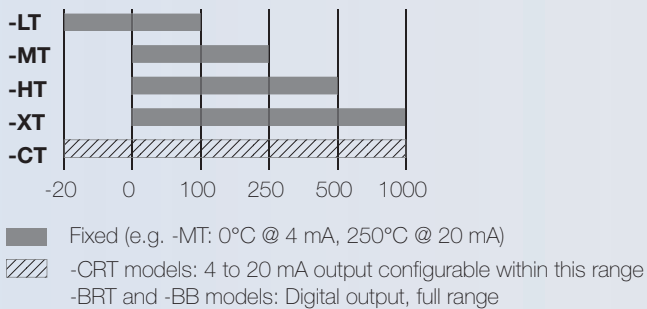

OUTPUT AND INTERFACE

- CB 4 to 20 mA output, no touch screen
- CRT 4 to 20 mA output and two alarm relay outputs, with touch screen
- BB RS485 Modbus output, no touch screen
- BRT RS485 Modbus output and two alarm relay outputs, with touch screen

EXAMPLE: PM-MA-301-CT-BRT

Series	Sensing Head Operating Temperature	Optics	Temperature Range	Output and Interface
PM PyroMini	-MA 0°C to 60°C	-301 30:1 divergent	-CT configurable within the limits: -20 to 1000 °C	-BRT RS485 Modbus output and two alarm relay outputs, with touch screen

## CONNECTIONS

### -CB and -CRT models

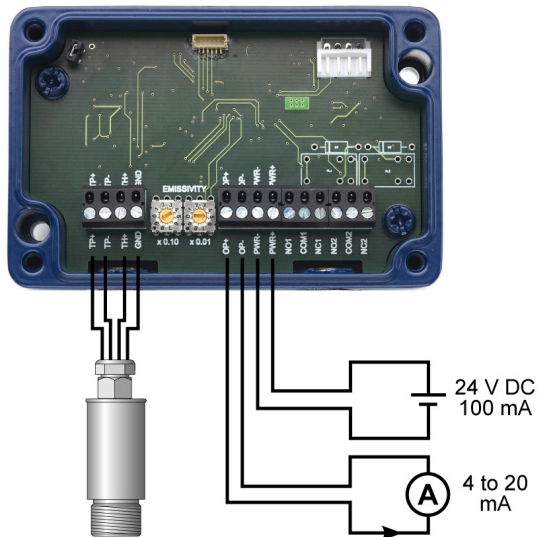

### -BB and -BRT models

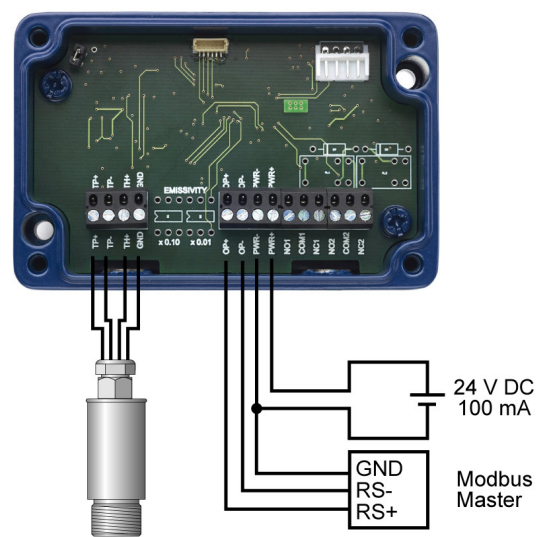

## DIMENSIONS AND ACCESSORIES

### Electronics Module

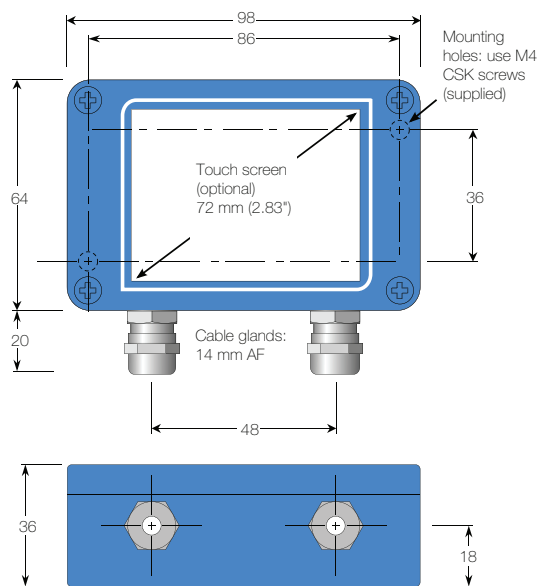

### Sensing Head

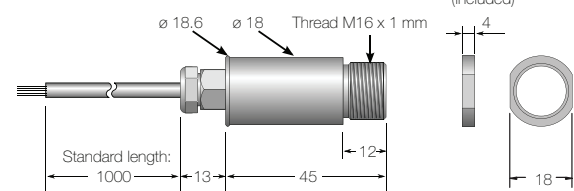

### Air Purge Collar

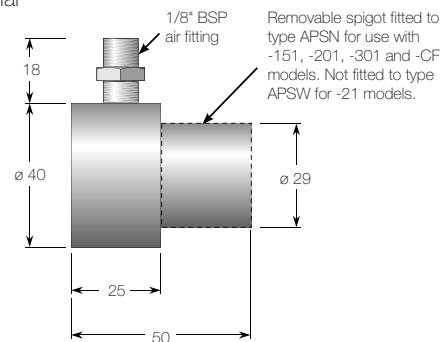

All dimensions in mm

## ACCESSORIES ALSO AVAILABLE

MicroSD Card with SD Card adapter: stores logged data (-CRT and -BRT models) **MSD**

Extended cable between sensing head and electronics module (-MA models) **PMCE** (-HA models) **PMCEHT**

Calibration certificate **CALCERTA**

Laser sighting tool **LSTS**

Protective plastic window in stainless steel holder **PWS**



Protective Plastic Window



Laser Sighting Tool

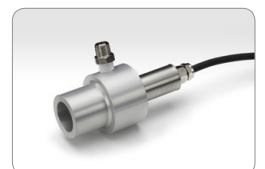

Air Purge Collar

## Calex Electronics Limited

PO Box 2, Leighton Buzzard, Bedfordshire, England LU7 4AZ  
Tel: +44 (0)1525 373178/853800 Fax: +44 (0)1525 851319 Lo-call Tel: 0845 3108053  
E-mail: mail@calex.co.uk Online: <http://www.calex.co.uk>

Issue C - Oct 12  
Specifications subject to change without notice