

PIXSYS
electronics

www.pixsys.net ☎ +39 041 5190518 R.A.

CODE : **2000.95.515**

PT100B-6x100-MGO-0000-DIN/B

DESCRIPTION :
PT100B sensor 6x100 mm, 3 wires connection,
no process connection with head DIN/B.
Thermowell code: 2000.30.017.

3 wires CONNECTION,

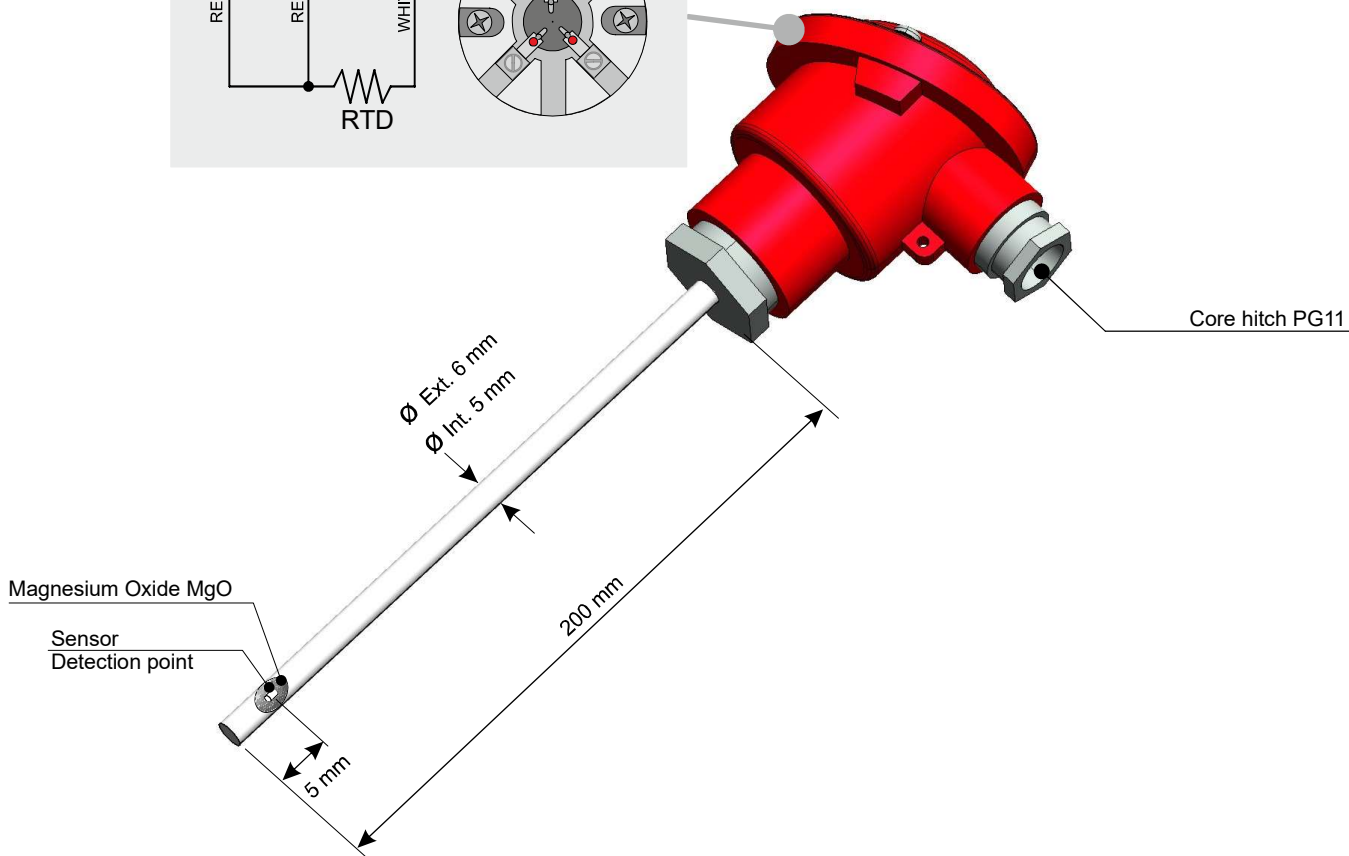
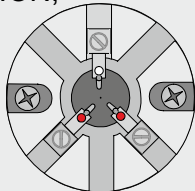
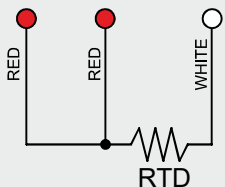

OPERATING TEMPERATURE :	-100°C + 500°C
HEAD MATERIAL :	Aluminium
IMMERSION MATERIAL :	Steel AISI 316L (food industry)
JUNCTION MATERIAL :	Not available
SENSOR INSULATION :	MgO Magnesium Oxide >20Mohm at 25°C (500Vdc)
TAPERING :	NO
CERTIFICATION :	NO

Response time of RTD with tube in steel AISI-316/304 MgO insulated, according to B.S. 1904/1984/CEI60751. 50mm water immersion at 1m/sec speed calculated on 63,2% of thermal gradient, according to stem diameter and thickness.

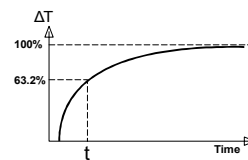

CONNECTION CABLE FEATURES					
SHEATH MATERIAL	TEMPERATURE [°C]		ABRASION RESISTANCE	HUMIDITY RESISTANCE	FLAME BEHAVIOUR
	EXERCISE	INSTANTANEOUS			
PVC	-30 / + 105	+ 105	Good	Good	Self-extinguish
GSC Silicon rubber	-40 / + 250	+ 250	Sufficient	Fair	Self-extinguish
TFE Teflon	-200 / + 260	+ 310	Excellent	Excellent	Self-extinguish
KAP Kapton	-200 / + 400	+ 440	Fair	Good	Self-extinguish
TTS Glass fiber	-200 / + 500	+ 500	Poor	Poor	Incombustible
TTC Ceramic fiber	+ 1000	+ 1100	Poor	Poor	Incombustible

External diameter	Internal diameter	t=Time
6 mm	5 mm	6,5 S
8 mm	7 mm	8,3 S
10 mm	9 mm	10,2 S

ACCORDING TO DIN EN 60751	TEMPERATURE	TOLERANCE
	°C	PT100 B Class (+/-°C)
	-200	1.3
	-100	0.8
	0	0.3
	100	0.8
	200	1.3
	300	1.8
	400	2.3
	500	2.8

EASYUP CONFIGURATION

To simplify installation start-up, "EasyUp" mode allows to select type of sensor and to fix its measuring range on the controller by entering a password (see table below).

EASYUP CODE FOR THIS SENSOR :

2200

SENSOR SELECTION :	PT100
LOWER LIMIT :	-100°C
UPPER LIMIT :	+500°C

ATR142 CONNECTION

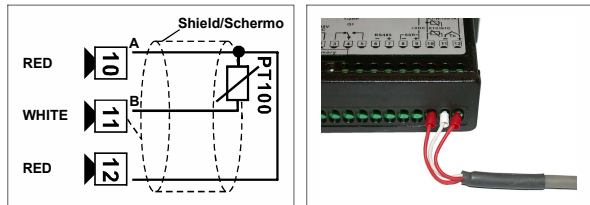

N.B. EasyUp on software version 1.12 or greater

ATR401 CONNECTION

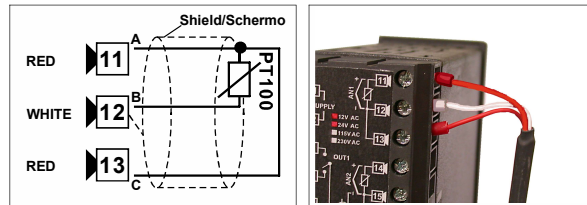

N.B. EasyUp on software version 1.01 or greater

ATR236/243 CONNECTION

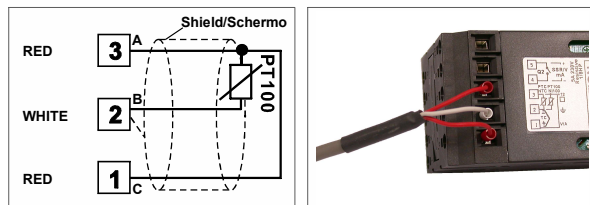

N.B. EasyUp on software version 1.18 or greater

DDR245 CONNECTION

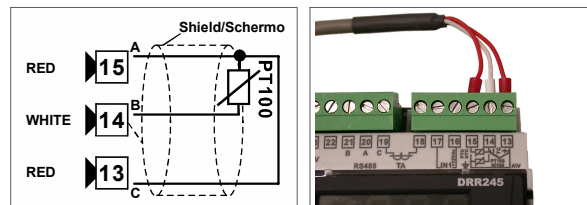

N.B. EasyUp on software version 1.18 or greater

COLLEGAMENTO ATR621 / 171

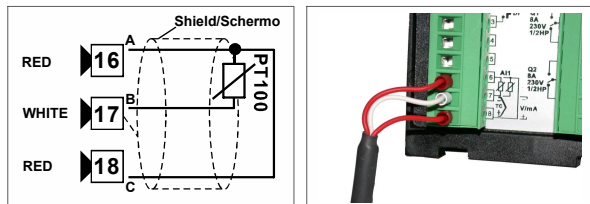

N.B. EasyUp on software version 1.01 or greater

THERMOWELL

THERMOWELL Code : 2000.30.018

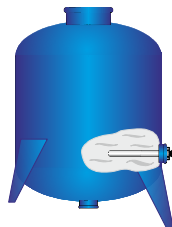
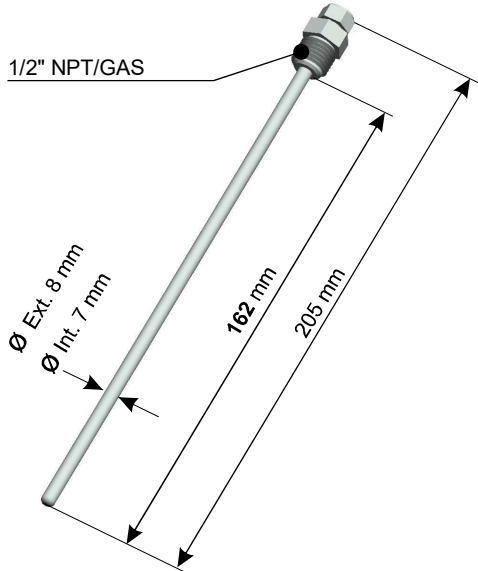

Fix thermowell to the process.

Place temperature sensor at the chosen depth, fix the junction with a 17mm spanner.

OPERATING TEMPERATURE :	-100°C + 900°C
MAXIMUM OPERATING PRESSURE :	100 Bar
IMMERSION MATERIAL :	Steel AISI 316L (food industry)