

EE210

Humidity and Temperature Transmitter for Demanding Climate Control Applications

The EE210 transmitter by E+E Elektronik meets the highest requirements in demanding climate control applications. Besides highly accurate measurement of relative humidity and temperature, EE210 calculates dew point temperature, absolute humidity and mixing ratio.

EE210 is available as wall or duct mounted as well as with remote probe. The enclosure minimizes installation costs and provides outstanding protection against contamination and condensation. All measured and calculated values are available on the Modbus RTU interface; two of the measured and calculated values are available on the analogue voltage or current outputs, while up to three values can be shown simultaneously on the optional display.

Excellent performance of EE210 in polluted, aggressive environment is ensured by the combination of completely protective encapsulated measurement electronics inside the sensing probe and the long-term stable HCT01 sensor with E+E proprietary coating.

With an optional configuration kit the user can setup, the Modbus interface parameters, the output scaling and perform one or two point adjustment for humidity and temperature.



EE210

Features

Appropriate for US mounting requirements

- » Knockout for 1/2" conduit fitting

External mounting holes

- » Mounting with closed cover
- » Electronics protected against construction site pollution
- » Easy and fast mounting

Electronics on the underside of the PCB

- » Optimum protection against mechanical damage during installation

Bayonet Screws

- » Open/closed with a 1/4 rotation

Cast Electronics

- » Mechanical protection
- » Condensation-resistant

E+E Humidity sensor HCT01

- » Long-term stability
- » Protected RH sensor surface
- » Protected solder pads
- » Tested according to automotive standard AEC-Q200

Display

- » Selectable display layout
- » Measurands freely selectable

Smooth cover surface

- » No accumulation of dust in protruding edges

Watertight cable outlet

Applications

- agriculture
- stables, incubators, hatcheries
- green houses
- storage rooms, cooling chambers
- indoor pools
- demanding climate control

Technical Data

Measured Values

Relative Humidity

Sensor	E+E Sensor HCT01-00D	
Analog output 0...100% RH	0-5 V	-1 mA < I _L < 1 mA
	0-10 V	-1 mA < I _L < 1 mA
	4-20 mA (two-wire)	R _L ≤ 500 Ohm

Working range 0...100% RH

RH accuracy (incl. hysteresis, non-linearity and repeatability)

Wall & duct version:

-15...40°C (5...104°F)	≤90% RH	±(1.3 + 0.003*measured value) % RH
-15...40°C (5...104°F)	>90% RH	± 2.3% RH
-40...60°C (0...140°F)		±(1.5 + 0.015*measured value) % RH

Remote probe version

at 20°C (68°F) ±2.5% RH

Temperature

Sensor Pt1000 (tolerance class B, DIN EN 60751) integrated in HCT01

Analog output ¹⁾	0-5 V	-1 mA < I _L < 1 mA
	0-10 V	-1 mA < I _L < 1 mA
	4-20 mA	R _L ≤ 500 Ohm

T-accuracy

wall & duct

remote probe

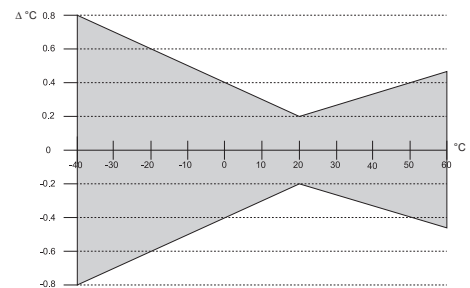
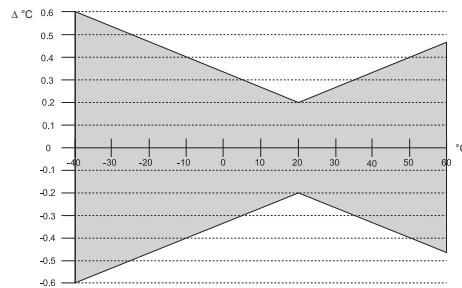

General

Power supply	for 0-5 V / 0-10 V	15 - 35V DC ²⁾ or 24V AC ±20%
	for 4-20 mA	10V + R _L x 20 mA < V+ < 30V DC
Current consumption		
Voltage output		DC supply typ. 3.3mA; with display typ. 3.6mA
		AC supply typ. 34mA; with display typ. 37mA
Current output		DC supply max. 40mA
Digital interface		DC supply typ. 5mA; with display typ. 19mA
		AC supply typ. 52mA; with display typ. 118mA
Connection		Screw terminals, max. 1.5 mm ²
Housing material		Polycarbonate, UL94V-0 (with Display UL94HB) approved
Protection class		IP65
Cable gland		M16 x 1,5
Probe cable (type C)		PVC, Ø 4.3mm, 4 x 0.25 mm ²
Sensor protection		E+E Coating
Electromagnetic compatibility		EN61326-1 EN61326-2-3
		Industrial Environment
Temperature ranges		Operating temperature: -40...60°C (-40...140°F)
		Storage temperature: -40...60°C (-40...140°F)
Temperature ranges with display		Operating temperature: -20...50°C (-4...122°F)
		Storage temperature: -20...60°C (-4...140°F)



¹⁾ Output scaling see Ordering Guide

²⁾ USA & Canada: class 2 supply required, max. supply voltage 30V

Dimensions (mm/inch)

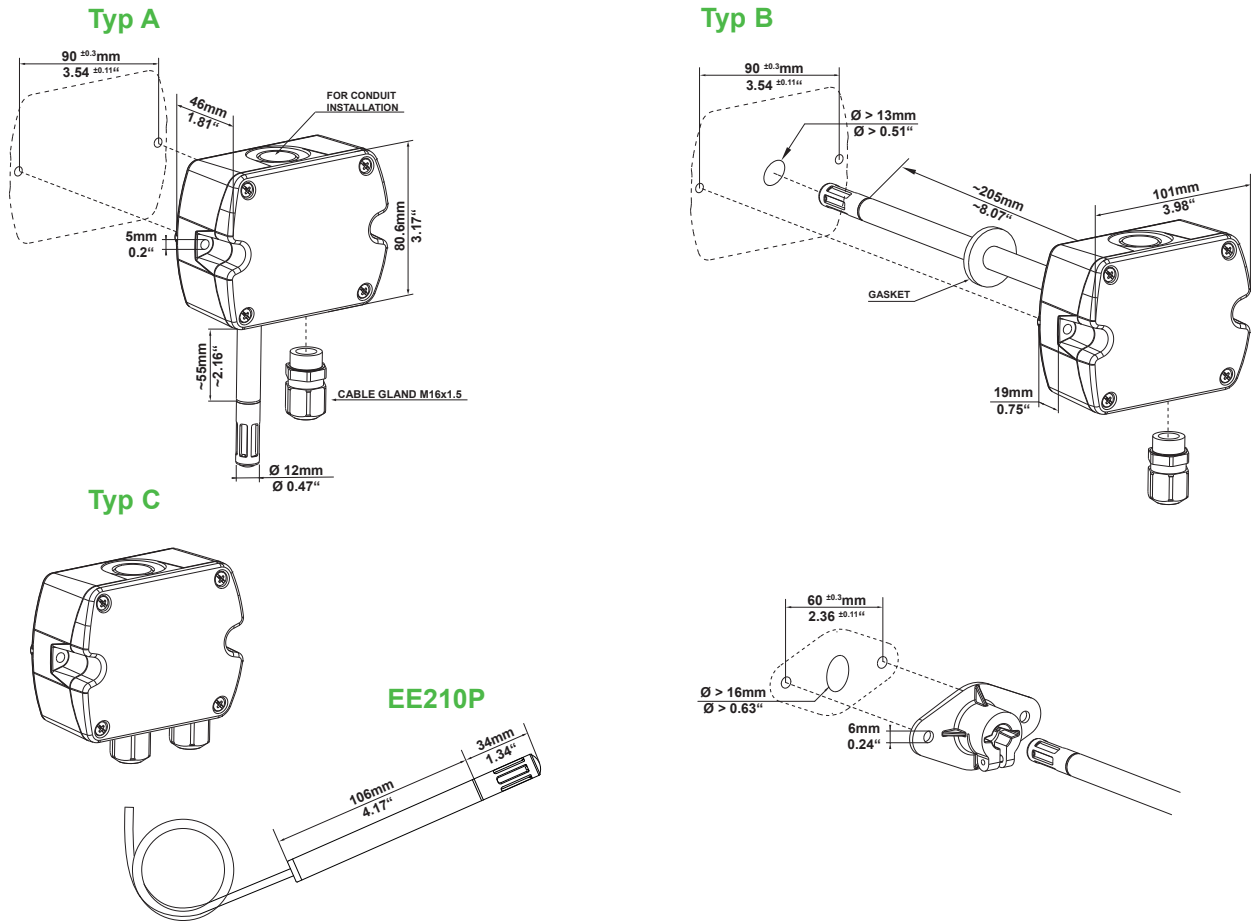

Connection Diagram

EE210-HT6

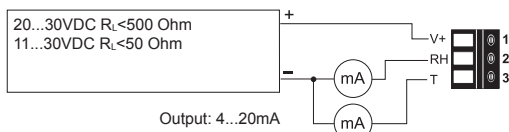

EE210-HT3

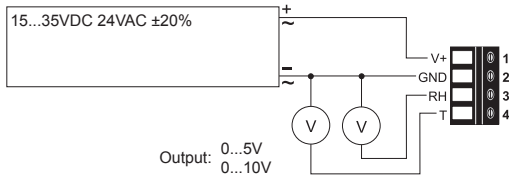

EE210-HTx3

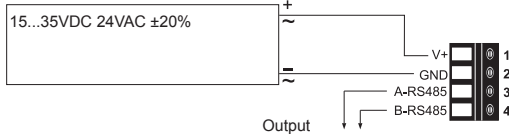

EE210P (for EE210-HT6 Type C)

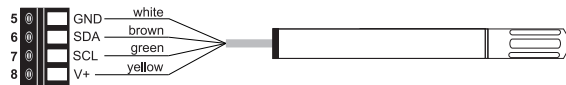

Ordering Guide

MODEL	ANALOGUE ¹⁾	DIGITAL ¹⁾	HOUSING	TYPE	DISPLAY ³⁾	FILTER (Type A and B)
humidity + temperature (HT)	0-5V (2) 0-10V (3) 4-20mA (6) none (x)	RS485 (3) none (x)	standard (P)	wall mount (A) duct mount (B) remote probe (C) ²⁾	display (D) none (x)	membrane (B) stainless steel sintered (D)
EE210-						

1) a combination of analog and digital version is not possible 2) The EE210P probe has to be ordered as separate position; for the moment available only for 4-20mA version

Analogue outputs setup

OUTPUT 1	SCALING 1 ⁵⁾	OUTPUT 2	SCALING 2 ⁵⁾	UNIT
relative humidity ⁴⁾ (Uw)	-40...60 (002)	relative humidity ⁴⁾ (Uw)	-40...60 (002)	metric (M)
temperature (Tx)	-10...50 (003)	temperature (Tx)	-10...50 (003)	non-metric (N)
dew point temperature (TD)	0...50 (004)	dew point temperature (TD)	0...50 (004)	
frost point temperature (TF)	0...100 (005)	frost point temperature (TF)	0...100 (005)	
water vapour partial pressure ⁴⁾ (Ex)	32...122 (076)	water vapour partial pressure ⁴⁾ (Ex)	32...122 (076)	
mixing ratio ⁴⁾ (Rx)	-40...140 (084)	mixing ratio ⁴⁾ (Rx)	-40...140 (084)	
absolute humidity ⁴⁾ (DV)		absolute humidity ⁴⁾ (DV)		
specific enthalpy ⁴⁾ (Hx)		specific enthalpy ⁴⁾ (Hx)		

3) Factory setup:
For analogue output versions the display shows the measurands selected for output 1 and output 2.
For digital output versions the display shows RH and T.

4) Factory Scaling

relative humidity	0...100% RH	
water vapour partial pressure	0...200mbar	0...3psi
mixing ratio	0...425g/kg	0...2900gr/lb
absolute humidity	0...150g/m ³	0...60gr/ft ³
specific enthalpy	0...400kJ/kg	0...200BTU/lb

5) For Tx, TD und TF:
other scaling upon request

Digital output setup⁶⁾

PROTOCOL	BAUDRATE	PARITY	STOPBITS	UNIT
modbus (1)	9600 (A)	odd (O)	1 stopbit (1)	metric (M)
	19200 (B)	even (E)	2 stopbit (2)	non-metric (N)
	38400 (C)	no parity (N)		

6) Modbus Map and setup instructions:
See User Guide and Modbus Application Note at www.epluse.com/EE210

Remote probe for EE210 Type C:

MODEL	CABLE LENGTH	FILTER
humidity + temperature (HT)	1.5 m (C) 3 m (E)	membrane (B) stainless steel sintered (D)
EE210P		

Order Examples

Type A and B

EE210-HT3xPAxB-UwTx005M

Model: Humidity+Temperature Transmitter
Analog output: 0-10V
Housing: standard
Type: wall mount
Display: none
Filter: membrane

Output scaling 1: relative humidity
Scaling 1: 0...100% RH
Output scaling 2: temperature
Scaling 2: 0...100°C
Unit: metric

Type C

Position 1:

EE210-HT6xPCx-UwTx005M

Model: Humidity+Temperature Basic Device
Analog output: 4-20mA
Housing: standard
Type: remote probe (Pos. 2)
Display: none

Output scaling 1: relative humidity
Scaling 1: 0...100% RH
Output scaling 2: temperature
Scaling 2: 0...100°C
Unit: metric

Position 2:

EE210P-HTCB

Model: Humidity+Temperature Probe
Cable length: 1.5 m
Filter: membrane

Accessories

Configurations kit consisting of:
- Product configuration adapter
- Product configuration software
- Connection cable for EE-PCA

EE-PCA (data sheet EE-PCA)
EE-PCS (free download: www.epluse.com/EE210)
HA011062