



Quick Start Guide PROFINET-Switch 4/8/16-port

Version

8^{en}
as of FW 1.08



Contents

1. Safety instructions.....	3
2. Introduction	4
3. Preparing the PROFINET-Switch.....	5
4. Planning of the GSDML files.....	6
5. Setting the port properties.....	7
6. Topology detection.....	7
7. Assign the PROFINET-Switch a name.....	8
8. Media Redundancy Protocol (MRP).....	9
9. Diagnosis and configuration via the web interface.....	10
10. Switch diagnosis and settings.....	12
11. Port mirroring.....	12
12. Statistics.....	13
13. Agents.....	14
14. SNMP.....	15
15. Setting the time.....	16
16. Resetting to factory settings.....	17
17. Firmware update.....	17
18. LED status information.....	18
19. Button functions.....	18
20. Technical data.....	19



1. Safety instructions

Target audience

This description is only intended for **trained personnel qualified** in control and automation engineering who are familiar with the applicable national standards.

For installation, commissioning, and operation of the components, compliance with the instructions and explanations in this operating manual is essential. The specialist personnel is to ensure that the application or the use of the products described fulfills all safety requirements, including all applicable laws, regulations, provisions, and standards.

Intended use

The device has a protection rating of IP 20 (open type) and must be installed in an electrical operating room or a control box/cabinet in order to protect it against environmental influences. To prevent unauthorized operation, the doors of control boxes/cabinets must be closed and possibly locked during operation.

The consequences of improper use may include personal injury to the user or third parties, as well as property damage to the control system, the product, or the environment. Use the device only as intended!

Operation

Successful and safe operation of the device requires proper transport, storage, setup, assembly, installation, commissioning, operation, and maintenance.

Operate the device only in flawless condition. The permissible operating conditions and performance limits (technical data) must be adhered to.

Retrofits, changes, or modifications to the device are strictly forbidden.

2. Introduction

This Quick Start Guide explains the basic settings for the initial commissioning of PROFINET-Switches for use in a PROFINET project.

You can find further information in the manual. You can find this under www.helmholz.de or scan the QR code directly.



*PROFINET-Switch
4-port, managed*



*PROFINET-Switch
8-port, managed*



*PROFINET-Switch
16-port, managed*

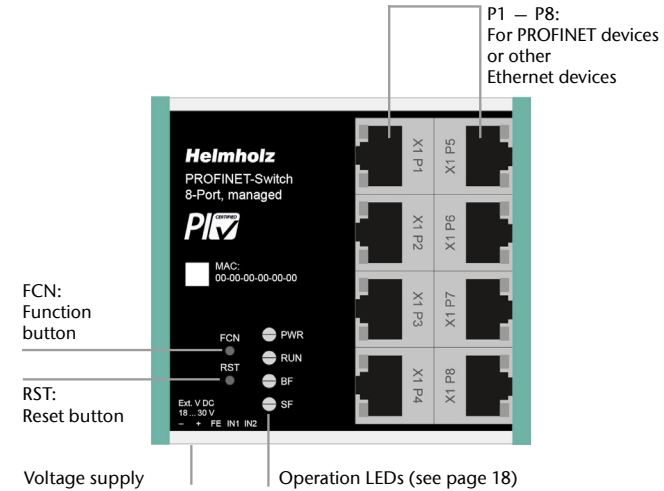
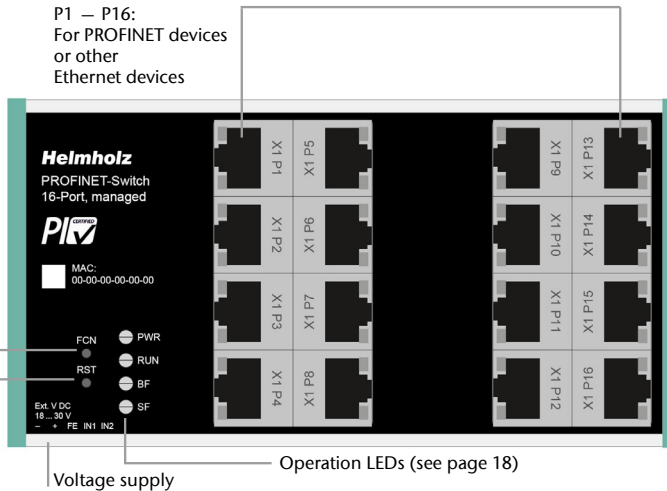
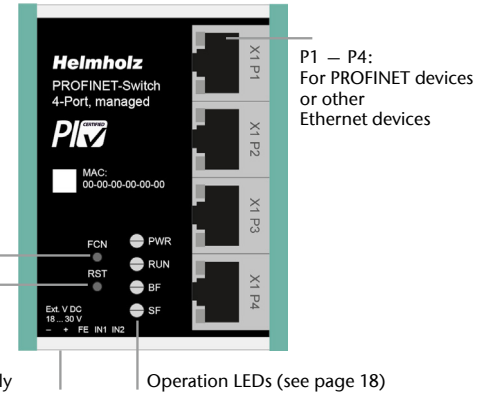

3. Preparing the PROFINET-Switch

3.1 Connection

The PROFINET-Switch must be supplied with 24 V DC at the wide range input 18 – 30 V DC via the provided connector plug.

The RJ45 sockets “P1 – P4” (4-port switch), “P1 – P8” (8-port switch) and “P1 – P16” (16-port switch) serve the connection of the network participants (PROFINET or Ethernet).

3.2 Install GSDML file

Please download the GSDML file under www.helmholz.de or scan the QR code.



*PROFINET-Switch
4-port, managed*



*PROFINET-Switch
8-port, managed*



*PROFINET-Switch
16-port, managed*



Note: The housing of the PROFINET-Switch is not grounded. Please connect the functional grounding connection (FG) of the PROFINET-Switch correctly with the reference potential.

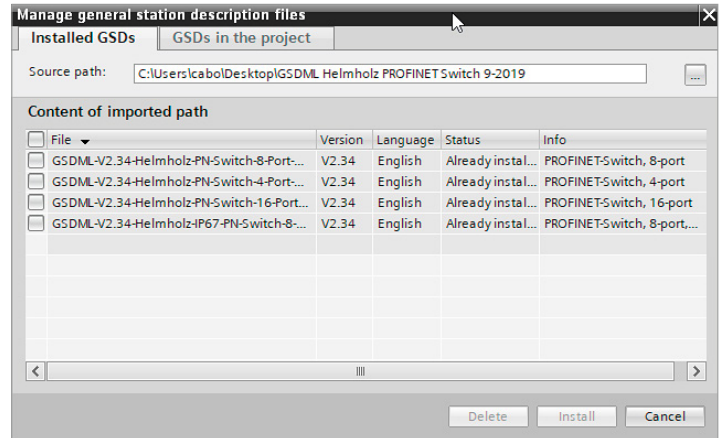

4. Planning of the GSDML files

Following installation, the PROFINET-Switch can be found in the hardware catalog under

“Other field devices → PROFINET IO → Network Components → Helmholz GmbH & Co. KG → Helmholz PN switch”. Add the “PROFINET-Switch, 4-port”, “PROFINET-Switch 8-port” or “PROFINET-Switch, 16-port” device to the project and connect it with your PROFINET network.

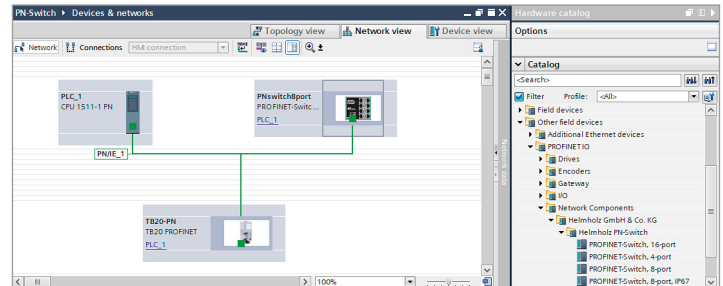

By calling up the object properties, you must assign the PROFINET-Switch a unique PROFINET name and check the IP address for plausibility in the project.

Important: The real device must later be assigned the same name as in the project. See also Chapter 6.

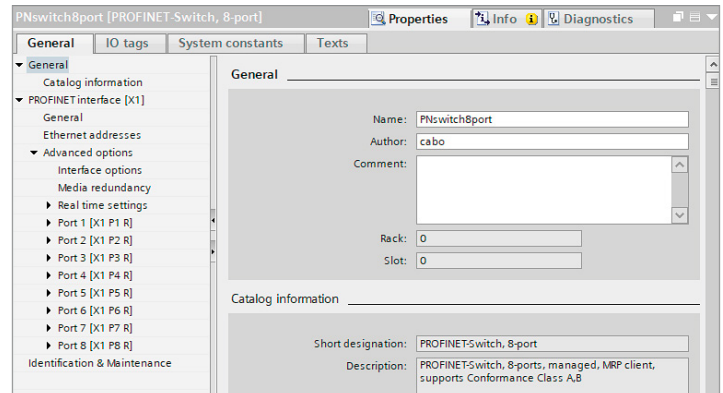

5. Setting the port properties

Each port of the PROFINET-Switch can be individually configured.

Transfer medium/duplex:

“Activate”	The port can be switched off here. This option is recommended when the port shouldn't be used. Unauthorized trespass into the network is prevented.
Transmission rate “Automatic”	The port synchronizes itself automatically with the communication partner (auto-negotiation).
“TP 100 Mbps”, Transmission rate full duplex	Fixed specification of the transmission rate. This option is recommended when connecting PROFINET IO devices.
Monitor	Send a diagnosis by Link Down
Enable autonegotiation	Automatic recognition of the transmission speed and the cable type (cross or patch cable)

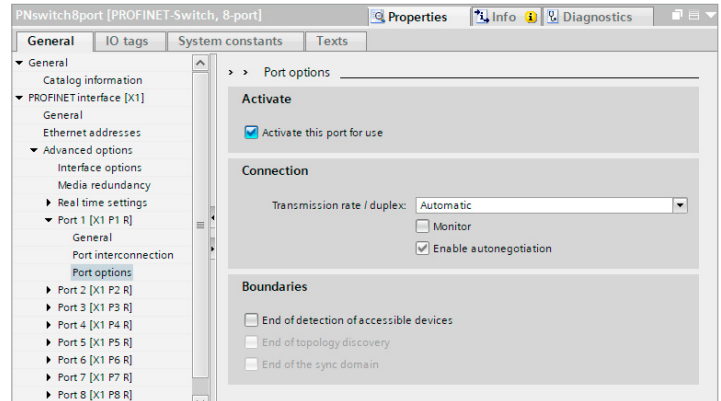

6. Topology detection

The PROFINET-Switch supports the mechanisms for neighborhood detection (LLDP). With this function it is possible to detect the topology of a PROFINET network, or to specify it for purposes of checking for the correct structuring by the configuration.

If the topology was prescribed in the configuration, neighboring devices can also be assigned the PROFINET name in the event of the replacement of a device.

This makes the recognition and testing of the network topology and the “device exchange in operation” of connected PROFINET participants possible.

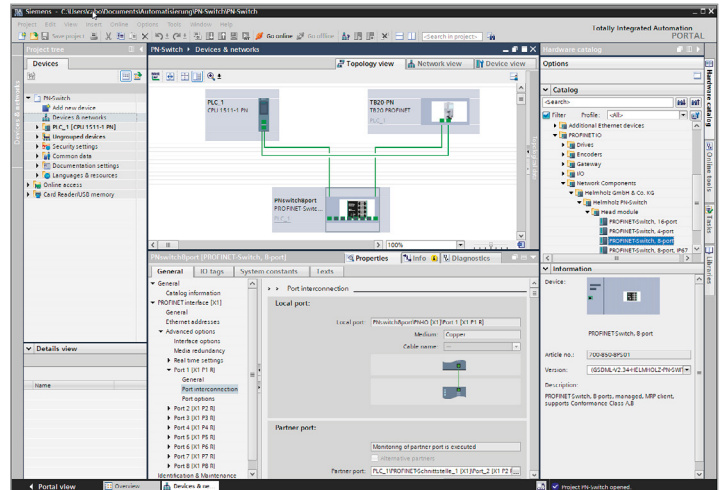

7. Assign the PROFINET-Switch a name

When the configuration of the PROFINET-Switch has been completed in the hardware configurator of the engineering tool, it can be loaded into the PLC.

In order that the PROFINET-Switch can be found by the PROFINET controller, the PROFINET device name must be assigned to the PROFINET-Switch. To this purpose, use the function “Assign device name”, which you can access in the Online menu with the right mouse button when the PROFINET-Switch is activated.

With the “Update list” button, the network can be browsed for PROFINET participants. The PROFINET device name can be assigned to the device with “Assign name”.

The clear identification of the PROFINET-Switch is ensured here by the MAC address of the device. The MAC address of the device can be found on the device front of the PROFINET-Switch.

The Helmholtz IPSet tool, which can be downloaded at no charge from the Helmholtz website, can also be used to set the PROFINET name.

If the PROFINET-Switch has been assigned the correct name, it is recognized by the PLC and configured. If configuration has taken place correctly, the PROFINET “BF” LED should be off.

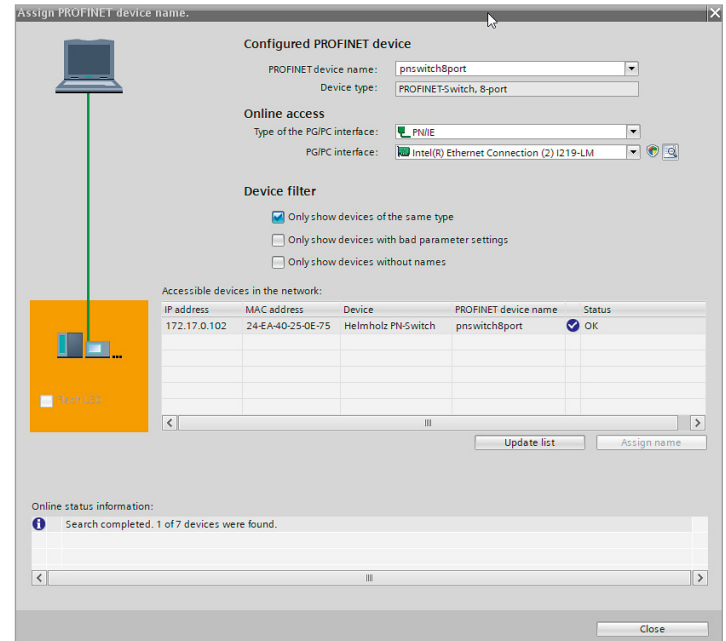

*PROFINET-Switch
4-port, managed*



*PROFINET-Switch
8-port, managed*



*PROFINET-Switch
16-port, managed*

8. Media Redundancy Protocol (MRP)

The PROFINET-Switch supports the optional media redundancy protocol (MRP) as MRP client. MRP enables ring wiring, which also makes operation of the PROFINET network possible in the event of the failure of a cable or of a participant.

There must be at least one MRP master (e.g. the CPU) in an MRP ring. All other participants of the ring are then MRP clients.

In order to assign the PROFINET-Switch to an MRP ring, the “Client” media redundancy role must be set for the “Media redundancy” option under “Properties/General”.

Important: *If ring wiring is produced without the MRP roles being configured for all devices involved, this can result in functional disruptions of the PROFINET network!*

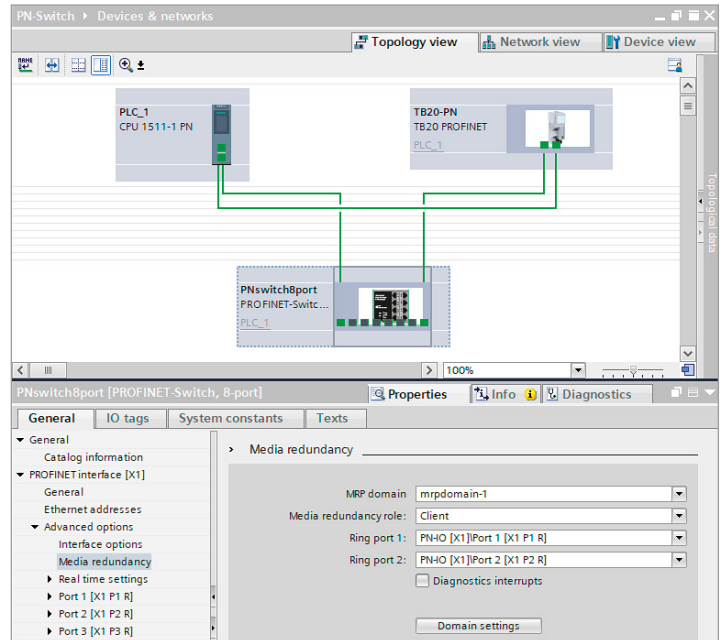

9. Diagnosis and configuration via the web interface

The web interface is also accessible under the IP address assigned to the PROFINET-Switch in the PROFINET network.

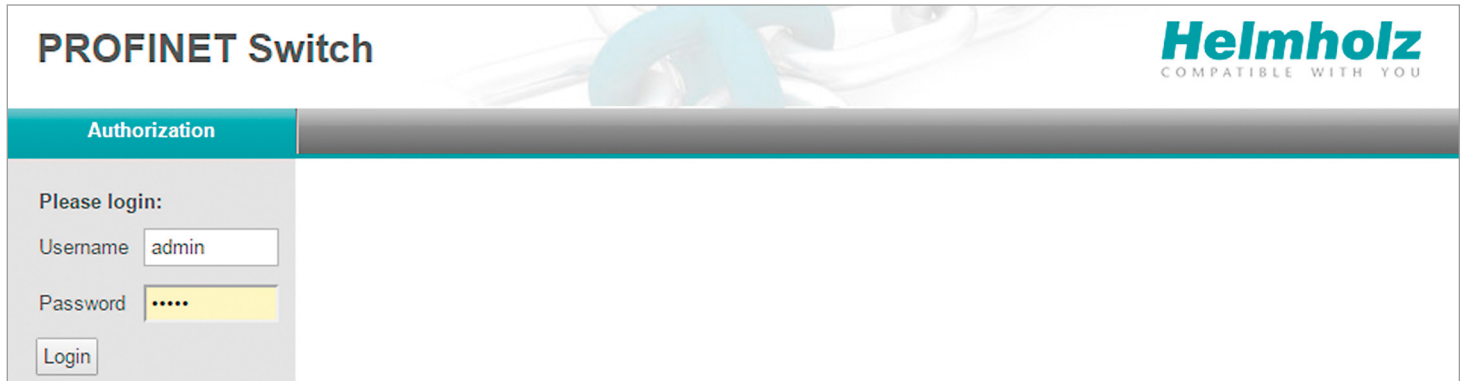

The screenshot shows the web interface for a PROFINET Switch. At the top left, the text "PROFINET Switch" is displayed. At the top right, the "Helmholz" logo is shown with the tagline "COMPATIBLE WITH YOU". Below the header is a teal bar with the word "Authorization". On the left side, there is a login form with the following elements:

- "Please login:" label
- "Username" field containing "admin"
- "Password" field containing "*****"
- "Login" button

When the web interface is first called up, the password of the “admin” user is the serial number of the device. The serial number is indicated on the right housing side part (e.g. “50001234”). It is absolutely necessary to assign a new password following the first login:

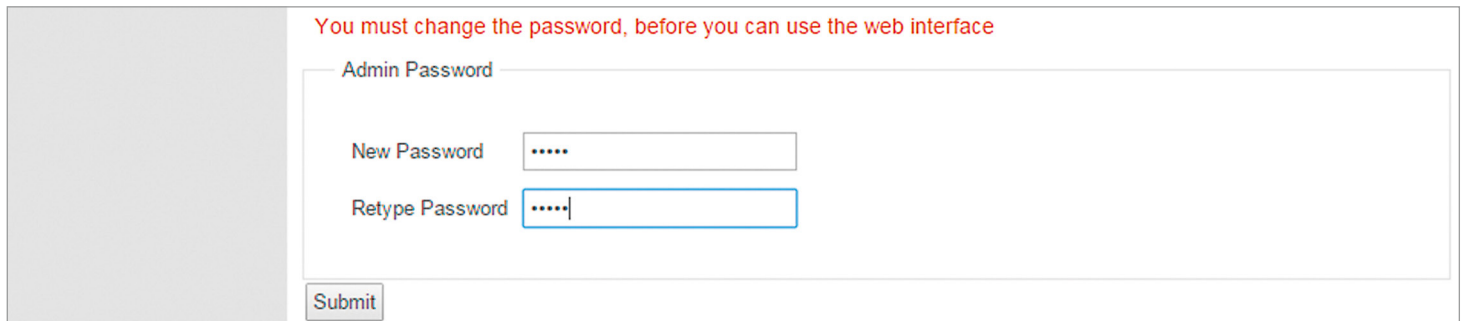

The screenshot shows the password change screen. At the top, a red message reads: "You must change the password, before you can use the web interface". Below this message are three input fields:

- "Admin Password" field (empty)
- "New Password" field containing "*****"
- "Retype Password" field containing "*****"

A "Submit" button is located at the bottom left of the form area.

One goes to the system view following entry of the new password:

System	Agent	Switch	Statistics	
Status	System Status			
Network	Device Type:	Helmholz PN-Switch		
Restart	Device MAC:	24-EA-40-20-00-D0		
Password	Protocol Status:	Connected		
Event Log	System Failure:	no		
	System Time:	--/--/---- --:--:--		
	System Up Time:	0 days 00:12:03		

Note: If the PROFINET-Switch is configured and used in a PROFINET network, settings in the web interface are only to be viewed as a diagnosis. A reconfiguration of PROFINET-related settings (Port Status, LLDP, DCP, Ring Redundancy) is then not possible in the web interface.

10. Switch diagnosis and settings

Extensive information and settings for the function of the switch are accessible in the Switch menu.

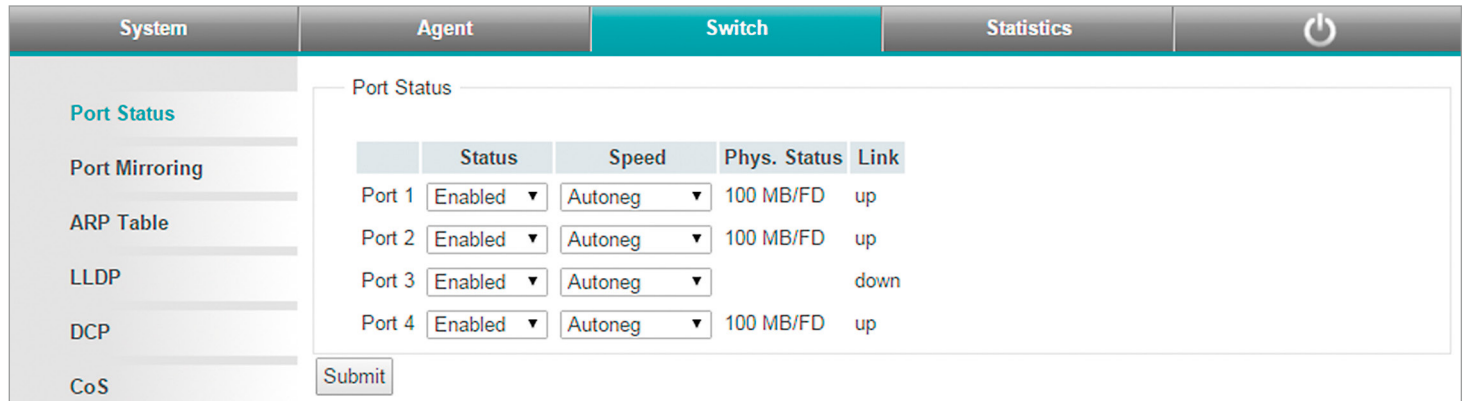

The screenshot shows the 'Switch' menu with the 'Port Status' option selected. The main content area displays a table of port configurations and a 'Submit' button.

	Status	Speed	Phys. Status	Link
Port 1	Enabled	Autoneg	100 MB/FD	up
Port 2	Enabled	Autoneg	100 MB/FD	up
Port 3	Enabled	Autoneg		down
Port 4	Enabled	Autoneg	100 MB/FD	up

Submit

11. Port mirroring

In order to be able to carry out frame analyses or recordings, Port Mirroring can be activated in the PROFINET-Switch. With Port Mirroring, the frame transfer from one "mirrored port" to the "Monitor Port" is completely mirrored, on which an analysis PC can then record everything.

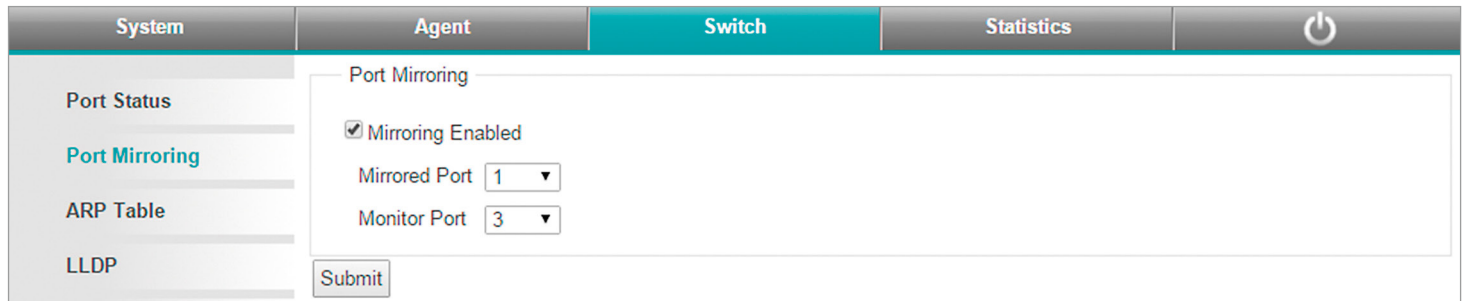

The screenshot shows the 'Switch' menu with the 'Port Mirroring' option selected. The main content area displays configuration options for port mirroring and a 'Submit' button.

Port Mirroring

Mirroring Enabled

Mirrored Port: 1

Monitor Port: 3

Submit

12. Statistics

Detailed statistics on the data transfer can be queried in the “Statistics” menu.

Among other things, the quality of the transmission can be monitored in the sub-menu “Statistics by Error”.

System	Agent	Switch	Statistics				
Statistics By Size	Received Packages By Size						
Statistics By Type	64	65-127	128-255	256-511	512-1023	1024-max.	
Statistics By Error	Port 1	2628	1575741	625	8	3	1
	Port 2	2593	1551554	3	622	1	0
	Port 3	0	0	0	0	0	0
	Port 4	204	74	401	7	52	0
	<input type="button" value="Refresh"/>	<input type="button" value="Reset Statistics"/>					

13. Agents

In order to already be able to view basic information about the switch at the start website, before or without having logged in, the option “System Status Without Login” can be selected. With “Web Session Timeout”, it can be established whether an automatic logout should take place in the event of inactivity at the website for security reasons.

System	Agent	Switch	Statistics	
WEB	Agent Configuration			
I&M0	System Status Without Login <input checked="" type="checkbox"/>			
SNMP	Web Session Timeout (Minutes) <input type="text" value="10"/>			
Ring Redundancy	<input type="button" value="Submit"/>			

14. SNMP

The PROFINET-Switch supports SNMP ("Simple Network Management Protocol") in order to also enable the identification and diagnosis of the switch for IT administration tools.

System	Agent	Switch	Statistics	
CLI & WEB	SNMP Settings			
I&M0	System Contact	<input type="text" value="Muster GmbH"/>		
SNMP	System Name	<input type="text" value="Max Mustermann"/>		
Ring Redundancy	System Location	<input type="text" value="Maschine 7"/>		
	<input type="button" value="Submit"/>			

15. Setting the time

The PROFINET-Switch contains a system clock for the issuing of logs and alarm messages. This can be set either manually or automatically by an SNTP server.

System	Agent	Switch	Statistics	
Status	Base Configuration		Daylight Saving Time	
Network	Time Synchronization: <input type="text" value="Manual Setting"/>		Year: <input type="text" value="YYYY"/> Start: <input type="text" value="MMDDhh"/> End: <input type="text" value="MMDDhh"/>	
Restart	Timezone Offset (Minutes): <input type="text" value="0"/>			
Password	<input type="button" value="Submit"/>		<input type="button" value="Submit"/>	
Event Log	Manual Time Setting			
Firmware	TIME (UTC): <input type="text" value="19"/> <input type="text" value="November"/> <input type="text" value="2015"/> <input type="text" value="13:16:00"/>			
Time	<input type="button" value="Submit"/>			

16. Resetting to factory settings

In order to reset the PROFINET-Switch to the delivery status, the function “Factory Reset” can be used in the web interface under “System” → “Restart”.

Alternatively, the PROFINET-Switch can be reset by pressing and holding the “FCN” button while the device restarts. A restart can be carried out by switching the power supply off and on or by activating the RST button.

The successful resetting of the parameters and settings is acknowledged during the boot process by the SF LED lighting up together with the PWR LED.

17. Firmware update

A firmware update can be carried out via the web interface.

The firmware update file can be selected in the menu “System → Firmware”.

The file has the ending “HUF” (Helmholz Update File).

The firmware is transferred to the PROFINET-Switch and burned with the “Send” button.

The new firmware is active following a restart of the PROFINET-Switch.

Important: Switching off the power supply during the update process can make the device unusable.

Please download the firmware update file under www.helmholz.de or scan the QR code.



PROFINET-Switch
4-port, managed



PROFINET-Switch
8-port, managed



PROFINET-Switch
16-port, managed



System	Agent	Switch	Statistics	
Status	<div><h3>Firmware Upgrade</h3><p>Please specify the image file:</p><input type="text"/> <input type="button" value="Browse"/> <input type="button" value="Send"/></div>			
Network				
Restart				
Password				
Event Log				
Firmware				
Time				

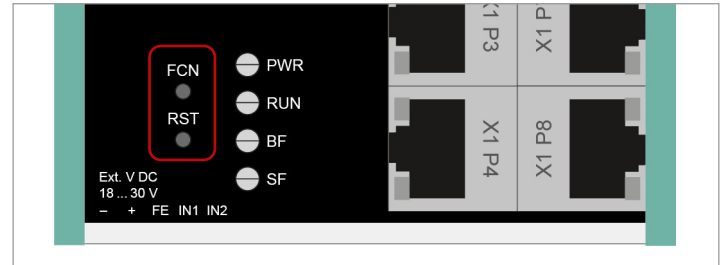
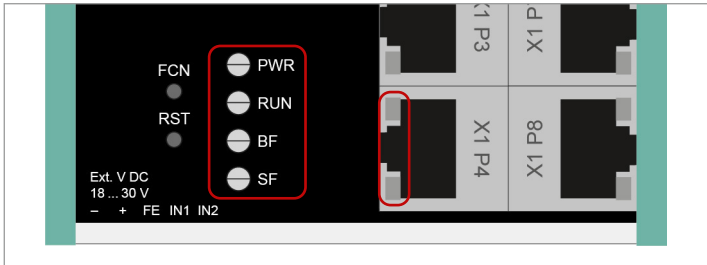

18. LED status information

PWR

Off	No power supply or device defective
On	Device is correctly supplied with voltage

RUN

Flashing light	The device starts
On	The device is ready to operate

BF

On	The device has no configuration and/or there is no connection with the PROFINET controller
----	--

SF

On	A PROFINET diagnosis is available
----	-----------------------------------

RJ45 LEDs

Green (Link)	Connected
Orange (Act)	Data transfer at the network

Note: The LEDs “RUN”, “BF”, and “SF” all flash synchronously when the PROFINET function for device identification has been activated.

19. Button functions

FCN

The PROFINET-Switch can be reset to factory settings with the “FCN” button.

If the “FCN” button is pressed during the run-up time of the switch, the orange “SF” LED begins to flash. The blinking indicates that the switch will be immediately reset to factory settings and restarted as soon as the switch is released.

The run-up phase is indicated by the blinking of the “RUN” LED.

RST

The “RST” button triggers an immediate restart of the PROFINET-Switch, in the course of which all saved settings are retained.

20. Technical data

	PROFINET-Switch, 4-port, managed 700-850-4PS01	PROFINET-Switch, 8-port, managed 700-850-8PS01	PROFINET-Switch, 16-port, managed 700-850-16P01
Dimensions (D x W x H)	32,5 x 58,5 x 76,5 mm	32,5 x 83,5 x 76,5 mm	32,5 x 147 x 76,5 mm
Weight	Approx. 130 g	Approx. 180 g	Approx. 310 g
PROFINET ports			
- Protocol	PROFINET IO as defined in IEC 61158-6-10	PROFINET IO as defined in IEC 61158-6-10	PROFINET IO as defined in IEC 61158-6-10
- Physical layer	Ethernet	Ethernet	Ethernet
- Transmission rate	100 Mbps, full duplex	100 Mbps, full duplex	100 Mbps, full duplex
- Connection	4 x RJ45, integrated switch	8 x RJ45, integrated switch	16 x RJ45, integrated switch
- Features	Media Redundancy Protocol (MRP) Automatic addressing/ Topology recognition (LLDP, DCP)	Media Redundancy Protocol (MRP) Automatic addressing/ Topology recognition (LLDP, DCP)	Media Redundancy Protocol (MRP) Automatic addressing/ Topology recognition (LLDP, DCP)
Status indicator	4 LEDs function status, 8 LEDs Ethernet status	4 LEDs function status, 16 LEDs Ethernet status	4 LEDs function status, 32 LEDs Ethernet status
Voltage supply	DC 24 V (18 ... 30 V DC)	DC 24 V (18 ... 30 V DC)	DC 24 V (18 ... 30 V DC)
Current draw	Max. 250 mA at 24 V DC	Max. 350 mA at 24 V DC	Max. 290 mA at 24 V DC
Power dissipation	Max. 2.4 W	Max. 2 W	Max. 5.5 W
Permissible ambient temperature	-40 °C ... +75 °C	-40 °C ... +75 °C	0 °C ... +60 °C
Transport and storage temperature	-40 °C ... +85 °C	-40 °C ... +85 °C	-40 °C ... +85 °C
Protection rating	IP 20	IP 20	IP20
Certifications	CE, UL	CE, UL	CE, UL
UL	UL 61010-1/ UL 61010-2-201	UL 61010-1/ UL 61010-2-201	UL 61010-1/ UL 61010-2-201
- Voltage supply	24 V DC (18 ... 30 V DC, SELV and limited energy circuit)	24 V DC (18 ... 30 V DC, SELV and limited energy circuit)	24 V DC (18 ... 30 V DC, SELV and limited energy circuit)
- Pollution degree	2	2	2
- Altitude	Up to 2,000 m	Up to 2,000 m	Up to 2,000 m
- Temperature cable rating	87 °C	87 °C	87 °C

Note:

The contents of this Quick Start Guide have been checked by us so as to ensure that they match the hardware and software described. However, we assume no liability for any existing differences, as these cannot be fully ruled out.

The information in this Quick Start Guide is, however, updated on a regular basis. When using your purchased products, please make sure to use the latest version of this Quick Start Guide, which can be viewed and downloaded on the Internet from www.helmholz.de.

Our products contain open source software, among others. This software is subject to the respectively relevant license conditions. We can send you the corresponding license conditions, including a copy of the complete license text together with the product. They are also provided in our download area of the respective products under www.helmholz.de. We also offer to send you or any third party the complete corresponding source text of the respective open source software for an at-cost fee of 10.00 Euro as a DVD upon request. This offer is valid for a period of three years, starting from the date of product delivery.

1) SIMATIC is a registered trademark of Siemens AG.

Our customers are at the center of everything we do. We welcome all ideas and suggestions.