

Solid State Relays 1-Phase, Soft Start Switching Types RGS1P..K..

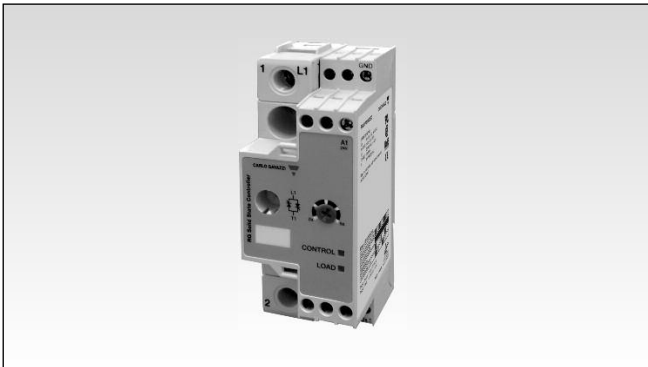

- 1-pole AC solid state relays
- Soft start switching for short wave infrared heaters
- Rated operational voltage: up to 660 VAC
- Rated operational current: up to 90 AAC
- Control input: 24VDC
- Integrated varistor protection on output
- Load ON LED indication
- 100kA short circuit current rating according to UL508



Product Description

The RGS1P..K provides a solution for starting of loads having a high cold to hot resistance ratio and hence it is very common for such loads to exhibit a high inrush current when switched on from a cold state. Such behaviour is very common for short wave infrared heaters.

When a control signal is applied to the RGS1P..K, a soft start is performed. The soft start time is settable through

an accessible potentiometer. Once the soft start is complete, the RGS1P..K output switches ON and OFF according to the control signal. Soft starting is performed again if the control signal has been missing for more than 5 seconds.

The output of the RGS1P is protected against overvoltages by means of an integrated varistor across the output. Two front LEDs indicate the status of the load and control

Specifications are at a surrounding temperature of 25°C unless otherwise specified.

Type Selection

SSR with no heatsink	Type of switching	Rated voltage (Ue), Blocking voltage	Control input	Rated current ¹ , I _{rt}	Connection configuration	External supply (Us)
RGS1: 1-pole switching	P: Proportional (Soft starting)	23: 85 - 265 VAC, 800 Vp	K: 24 VDC +/-20%	50: 50 AAC, 1,800 A ² s	E: Contactor	D: 24 VDC/ AC
		48: 190 - 550 VAC, 1200 Vp		92: 90 AAC, 18,000 A ² s		
		60: 410 - 660 VAC, 1200 Vp				

1: Max. ratings with suitable heatsink. Refer to Heatsink Selection tables for further details.

Ordering Key

RGS 1 P 48 K 50 E D

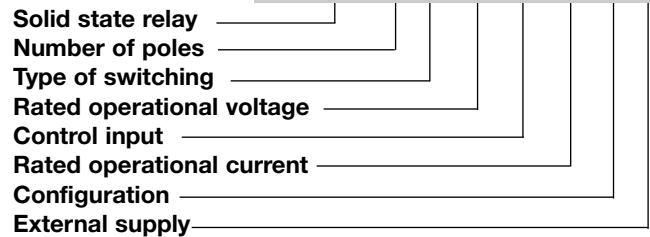

Selection Guide

Output voltage, Ue	Control input	External supply, Us	Power connection	Rated operational current (I _t value)	
				Product width	
				50 AAC (1,800 A ² s) 35 mm	90 AAC (18,000 A ² s) 35 mm
85 - 265 VAC	19.2 - 28.8 VDC	24 VDC/AC	Screw	RGS1P23K50ED	-
			Box	-	RGS1P23K92ED
190 - 550 VAC	19.2 - 28.8 VDC	24 VDC/AC	Screw	RGS1P48K50ED	-
			Box	-	RGS1P48K92ED
410 - 660 VAC	19.2 - 28.8 VDC	24 VDC/AC	Screw	RGS1P60K50ED	-
			Box	-	RGS1P60K92ED

General Specifications

Operational frequency range	45 to 65 Hz	Pollution degree	2 (non-conductive pollution with possibilities of condensation)
Power factor	> 0.7 @ rated voltage	Over-voltage category	III (fixed installations)
Touch Protection	IP20	Isolation	4000 Vrms 2500 Vrms
LED status indication ²		L1, T1, A1, GND, Us to case	
Green	Control ON, fully ON Supply ON, flashing 0.5s ON, 0.5s OFF	L1, T1 to A1, GND, Us	
Yellow	Load ON		

2: Refer to LED Indications section

Output Voltage Specifications

	RGS1P23..	RGS1P48..	RGS1P60..
Operational voltage range (Ue)	85-265 VAC	190-550 VAC	410-660 VAC
Blocking voltage	800 Vp	1200 Vp	1200 Vp
Leakage current @ rated voltage	≤ 5 mAAC	≤ 5 mAAC	≤ 5 mAAC
Internal Varistor across output	Yes	Yes	Yes

Output Specifications

	RGS1P..50	RGS1P..92
Rated operational current per pole ³ AC-51	50 AAC	90 AAC
AC-55b	50 AAC	90 AAC
Minimum operational current	250 mAAC	500 mAAC
Rep. Overload Current PF = 0.7 UL508: T=40°C, tON=1s, tOFF=9s, 50cycles	107 AAC	168 AAC
Maximum transient surge current (I _{tsm}), t=10ms	600 Ap	1900 Ap
I ² t for fusing (t=10ms), minimum	1800 A ² s	18000 A ² s
Critical dv/dt (@ T _j init = 40°C)	1000 V/us	1000 V/us

3: Max. current with suitable heatsink. Refer to Heatsink Selection tables.

Input Specifications

Control input (A1 - GND)	19.2 - 28.8 VDC
Pick up voltage	19.2 VDC
Drop out voltage	10.0 VDC
Maximum initialisation time	250 ms
Response time (Input to Output)	2 half cycles
Input impedance	100k ohms
Reverse protection	Yes
Input protection vs. surges ⁴	Yes
Overvoltage protection	up to 30 VDC

4. Refer to Electromagnetic Compatibility section

5. To be supplied from a Class 2 power source

Supply Specifications

Supply voltage range (U _s) ⁵	24 VDC, -15% / +20% 24 VAC, -15% / +15%
Overvoltage protection	up to 32 VDC/AC for 30 sec.
Reverse Protection	Yes
Surge Protection ⁵	Yes, integrated
Max. supply current	30 mA



Output Power Dissipation

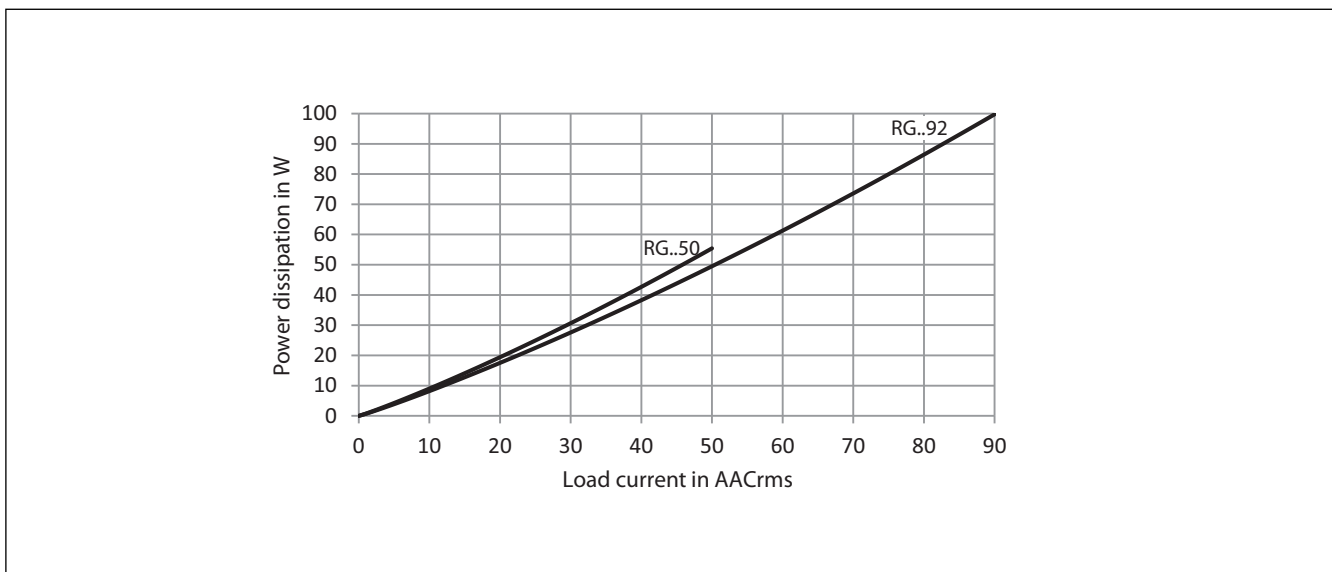

Heatsink Selection

RGS1P..50

Load current [A]	Thermal resistance [°C/W]					
	20	30	40	50	60	70
50.0	1.45	1.28	1.06	0.87	0.68	0.49
45.0	1.72	1.50	1.29	1.07	0.85	0.64
40.0	2.00	1.75	1.50	1.25	1.00	0.75
35.0	2.35	2.06	1.76	1.47	1.18	0.88
30.0	2.83	2.48	2.13	1.77	1.42	1.06
25.0	3.52	3.08	2.64	2.20	1.76	1.32
20.0	4.58	4.01	3.44	2.86	2.29	1.72
15.0	6.40	5.60	4.80	4.00	3.20	2.40
10.0	10.19	8.92	7.64	6.37	5.10	3.82
5.0	---	19.51	16.72	13.94	11.15	8.36

Ambient temp [°C]

RGS1P..92

Load current [A]	Thermal resistance [°C/W]					
	20	30	40	50	60	70
90.0	0.62	0.52	0.41	0.31	0.21	0.11
81.0	0.77	0.66	0.54	0.42	0.31	0.19
72.0	0.97	0.83	0.70	0.56	0.43	0.29
63.0	1.23	1.07	0.91	0.75	0.59	0.43
54.0	1.55	1.35	1.16	0.97	0.77	0.58
45.0	1.93	1.69	1.45	1.21	0.97	0.73
36.0	2.53	2.21	1.89	1.58	1.26	0.95
27.0	3.55	3.11	2.66	2.22	1.77	1.33
18.0	5.67	4.97	4.26	3.55	2.84	2.13
9.0	12.46	10.90	9.34	7.79	6.23	4.67

Ambient temp [°C]

Maximum junction temperature	125°C
Heatsink temperature	100°C
Junction to case thermal resistance, Rthjc	<0.3 °C/W
Case to heatsink thermal resistance, Rthcs ⁶	< 0.25 °C/W

Maximum junction temperature	125°C
Heatsink temperature	100°C
Junction to case thermal resistance, Rthjc	<0.20 °C/W
Case to heatsink thermal resistance, Rthcs ⁶	< 0.25 °C/W

6: Case to heatsink thermal resistance values indicated are applicable upon application of a fine layer of silicon based thermal paste HTS02S from electrolube between SSR and heatsink or mounting surface.

Environmental and Housing Specifications

Operating Temperature	-40°C to +70°C (-40°F to +158°F)	GWIT & GWFI (for plastic)	conform to EN 60335-1 requirements
Storage Temperature	-40°C to +100°C (-40°F to +212°F)		
RoHS (2011/65/EU)	Compliant	Installation altitude	0-1000m. Above 1000m derate linearly by 1% of FLC per 100m up to a maximum of 2000m
Impact resistance (EN50155, EN61373)	15/11 g/ms		
Vibration resistance (2-100Hz, EN50155, EN61373)	2g per axis	Weight RGS1P..50 RGS1P..92	approx. 170 g approx. 180 g
Relative humidity	95% non-condensing @ 40°C		
Material	PA66, RAL7035		
UL flammability rating (for plastic)	UL 94 V0		

Agency Approvals and Conformances

Conformance	IEC/EN 60947-4-3	Agency Approvals	UR: UL508 Recognised, NMFT2 E172877 cUR: CSA 22.2 No.14-13, NMFT8 E172877 CSA: CSA 22.2 No.14-13, 204075
		Short Circuit Current Rating	100kArms, UL508



Electromagnetic Compatibility

EMC Immunity	EN/IEC 61000-6-2	Electrical fast transient (Burst) immunity Output: 2kV, 5kHz Us : 2kV, 5kHz A1, GND : 1kV, 5kHz	EN/IEC 61000-4-4 Performance Criteria 1 Performance Criteria 1 Performance Criteria 1
Electrostatic discharge (ESD) immunity Air discharge, 8kV Contact, 4kV	EN/IEC 61000-4-2 Performance Criteria 2 Performance Criteria 2	Radiated radio frequency immunity 10V/m, 80 - 1000MHz 10V/m, 1.4 - 2.0GHz 3V/m, 2.0 - 2.7GHz	EN/IEC 61000-4-3 Performance Criteria 1 Performance Criteria 1 Performance Criteria 1
Electrical surge immunity Output, line to line, 1kV Output, line to earth, 2kV A1, GND Line to earth, 1 kV Us +, Us - Line to line, 500V Line to earth, 500V	EN/IEC 61000-4-5 Performance Criteria 2 Performance Criteria 2 Performance Criteria 2 Performance Criteria 2 Performance Criteria 2	Conducted radio frequency immunity 10V/m, 0.15 - 80MHz	EN/IEC 61000-4-6 Performance Criteria 1
		Voltage Dips 0% for 0.5/1cycle 40% for 10cycles 70% for 250cycles	EN/IEC 61000-4-11 Performance Criteria 2 Performance Criteria 2 Performance Criteria 2
		Voltage Interruptions 0% for 5000ms	EN/IEC 61000-4-11 Performance Criteria 2
EMC Emission	EN/IEC 61000-6-4	emission (radiated) 30 - 1000MHz	EN/IEC 55011 Class A (industrial)
Radio interference voltage emission (conducted) 0.15 - 30MHz Radio interference field	EN/IEC 55011 Class A (with external filtering)		

Note:

- Control input lines must be installed together to maintain products susceptibility to Radio Frequency Interference.
 - Use of AC solid state relays may according to the application and the load current, cause conducted radio interferences. Use of mains filters may be necessary for cases where the user must meet E.M.C requirements. The filtering tables should be taken only as indications, the filter attenuation will depend on the final application.
 - This product has been designed for Class A equipment. (External filtering may be required, refer to filtering section). Use of this product in domestic environments may cause radio interference, in which case the user may be required to employ additional mitigation methods.
 - Surge tests on RGC..A models were carried out with the signal line impedance network. In case the line impedance is less than 40Ω, it is suggested that AC supply is provided through a secondary circuit where the short circuit limit between conductors and ground is 1500VA or less.
 - A deviation of one step in the distributed full cycle models and up to 1.5% Full Scale Deviation in phase angle models is considered to be within PC1 criteria.
- Performance Criteria 1 (Performance Criteria A): No degradation of performance or loss of function is allowed when the product is operated as intended.
- Performance Criteria 2 (Performance Criteria B): During the test, degradation of performance or partial loss of function is allowed. However, when the test is complete the product should return operating as intended by itself.
- Performance Criteria 3 (Performance Criteria C): Temporary loss of function is allowed, provided the function can be restored by manual operation of the control.

Product Interface

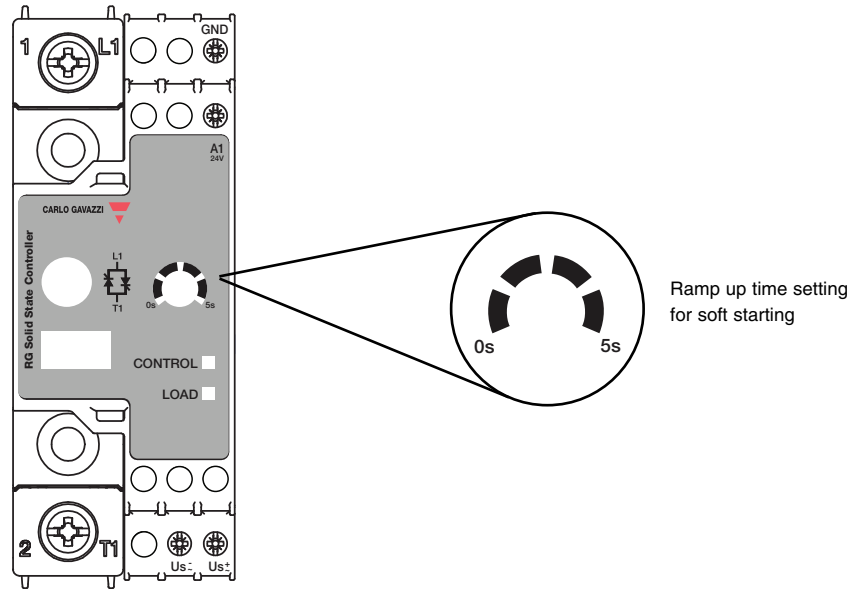

Terminals Labelling:

- 1/L1: Line connection
- 2/T1: Load connection
- A1-GND: Control input, 19.2 - 28.8 VDC
- Us (+, -): External supply, positive signal or AC signal
- Us (-, ~): External supply, ground or AC signal

LED Indications

LED	Status	Timing Diagram
CONTROL (green)	Supply voltage (Us) ON	[Timing diagram showing a continuous high pulse]
	Control input ON	[Timing diagram showing a continuous high pulse]
	Mains loss	[Timing diagram showing a pulse with a 0.5s duration]
	SSR internal error	[Timing diagram showing a pulse with a 3s duration]
LOAD (yellow)	LOAD ON	[Timing diagram showing a continuous high pulse]

Mode of Operation

Soft starting is utilised to reduce the start-up current of loads having a high cold to hot resistance ratio such as short wave infrared heaters. The thyristor firing angle is gradually increased over a time period of maximum 5 seconds (settable through an accessible potentiometer) in order to apply the voltage (and current) to the load smoothly.

Soft starting is performed only on the first power up and when the control voltage has been missing in the preceeding 5 seconds. If soft start is stopped before soft start completion, it is assumed that a start was performed and the period count for missing control voltage starts as soon as the soft start is stopped.

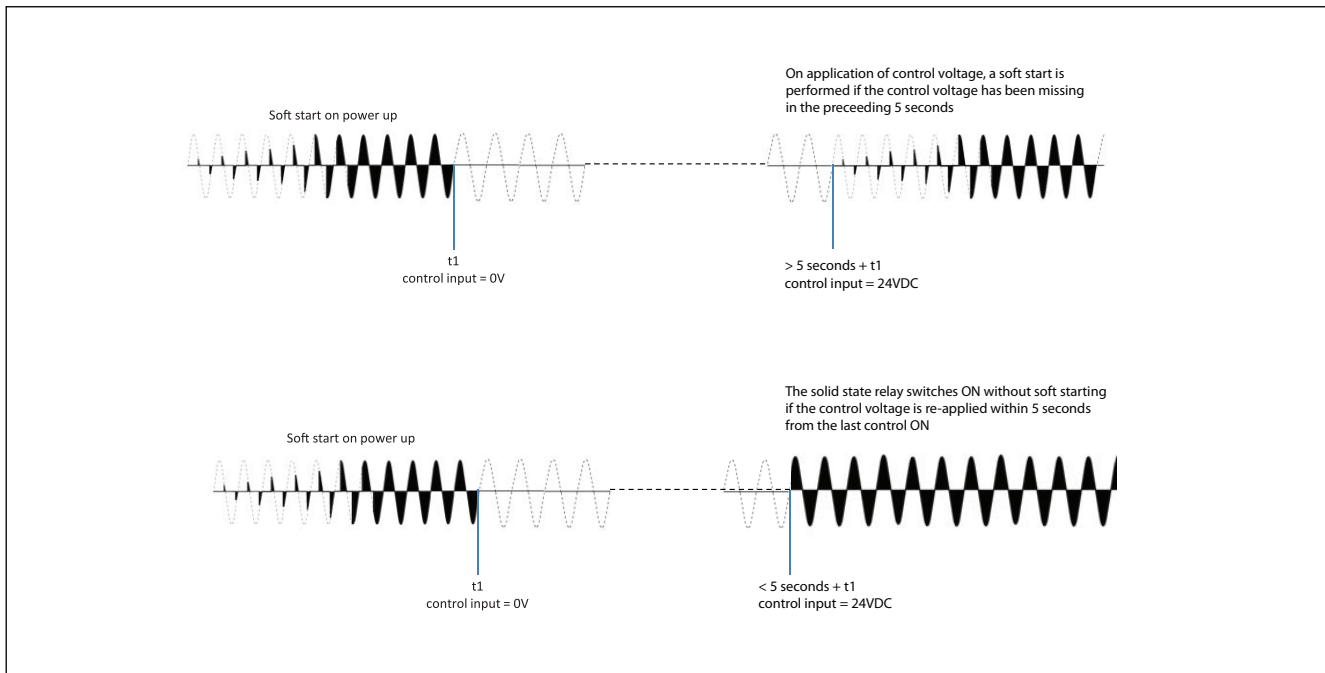

Dimensions

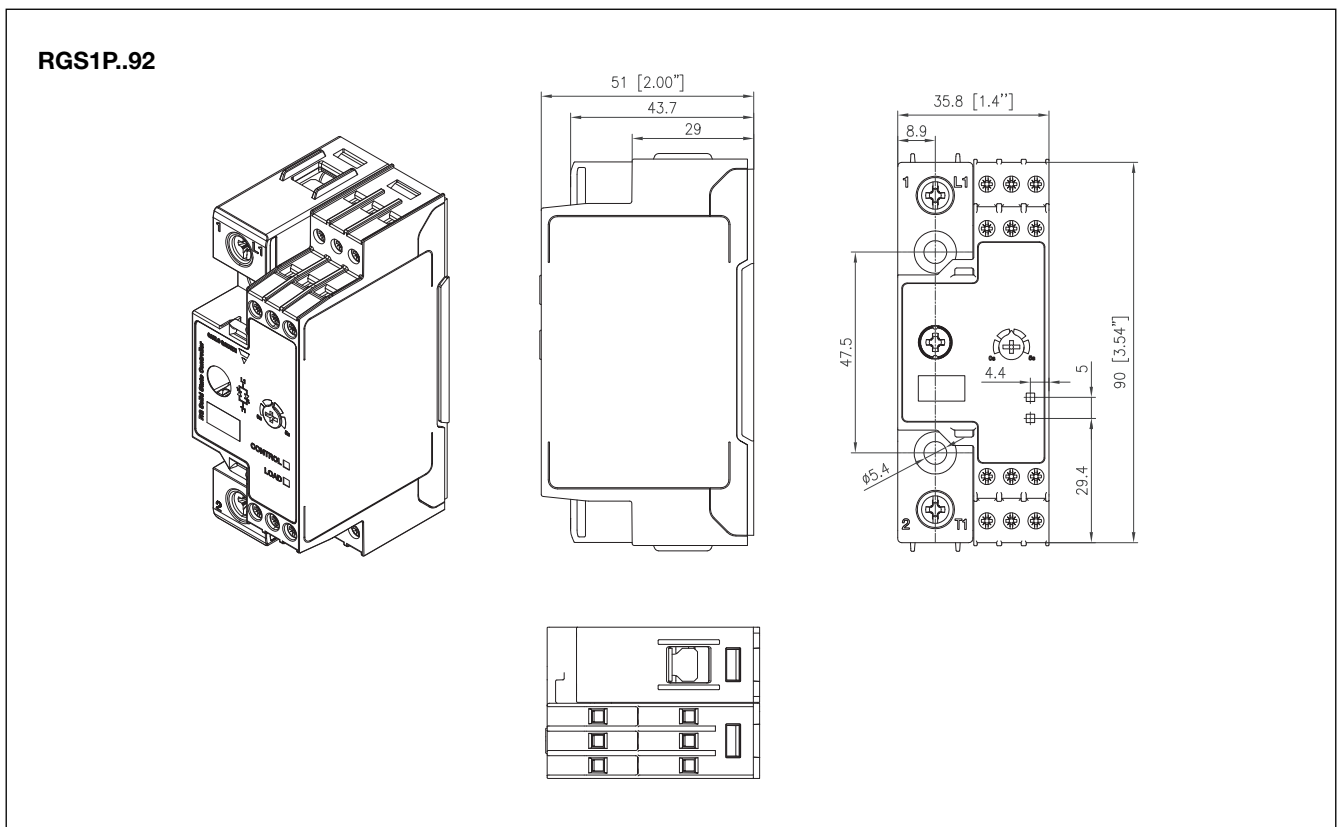
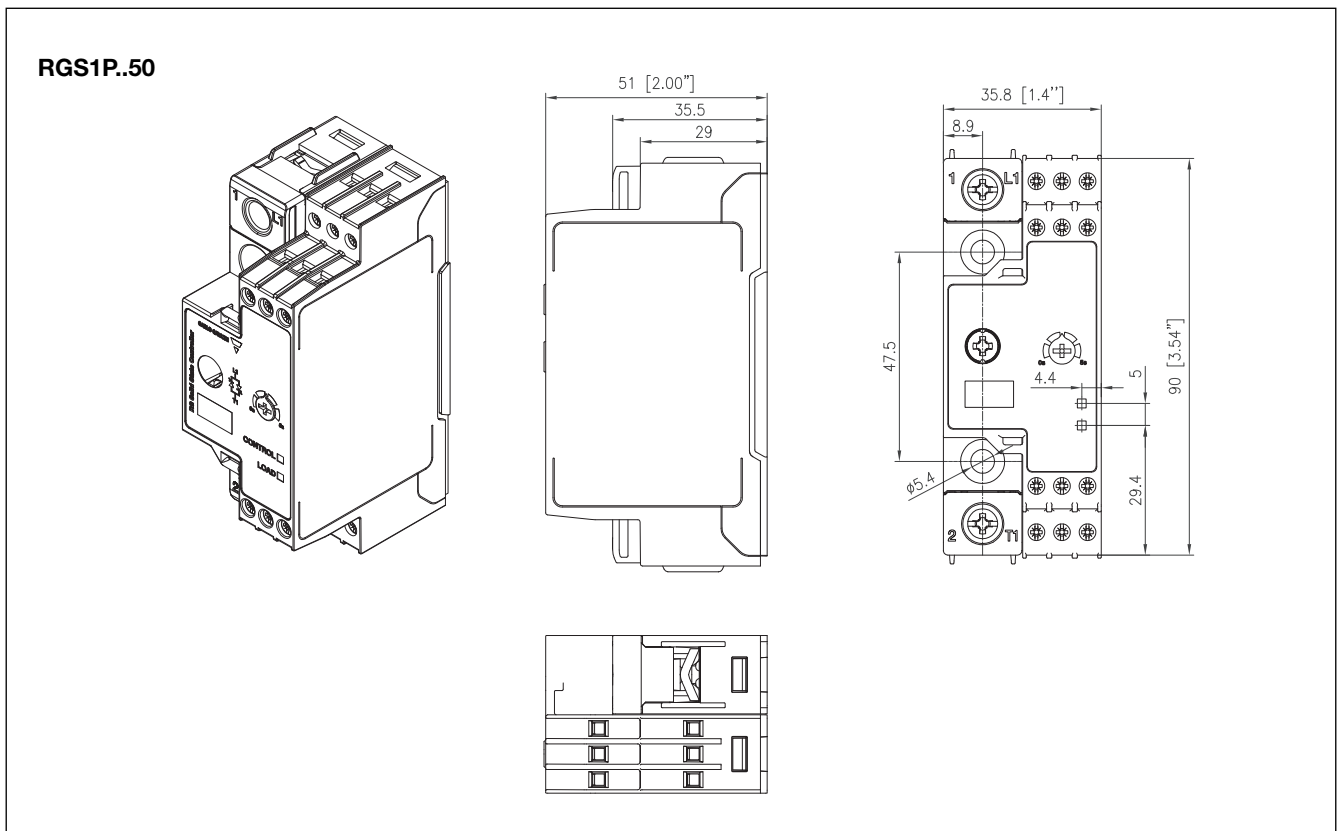

Connection Specifications

POWER CONNECTIONS





Use 75°C copper (Cu) conductors

1/L1, 2/T1

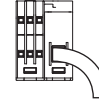
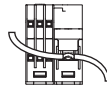
RGS1P..50

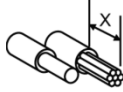
RGS1P..92





Stripping length (X)		12mm		11mm
Connection type		M4 screw with captivated washer		M5 screw with box clamp
Rigid (solid & stranded)		2x 2.5 - 6.0 mm ²	1x 2.5 - 6.0 mm ²	1x 2.5 - 25 mm ²
UL/CSA rated data		2x 14 - 10 AWG	1x 14 - 10 AWG	1x 14 - 3 AWG
Flexible with end sleeve		2x 1.0 - 2.5 mm ² 2x 2.5 - 4.0 mm ² 2x 18 - 14 AWG 2x 14 - 12 AWG	1x 1.0 - 4.0 mm ² 1x 18 - 12 AWG	1x 2.5 - 16 mm ² 1x 14 - 6 AWG
Flexible without end sleeve		2x 1.0 - 2.5 mm ² 2x 2.5 - 6.0 mm ² 2x 18 - 14 AWG 2x 14 - 10 AWG	1x 1.0 - 6.0 mm ² 1x 18 - 10 AWG	1x 4.0 - 25 mm ² 1x 12 - 3 AWG
Torque specification		Pozidriv 2 UL: 2Nm (17.7 lb-in) IEC: 1.5-2.0Nm (13.3-17.7 lb-in)		Pozidriv 2 UL: 2.5Nm (22 lb-in) IEC: 2.5-3.0Nm (22-26.6 lb-in)
Aperture for termination lug		12.3mm		n/a

CONTROL CONNECTIONS

Use 60/75°C copper (Cu) conductors

GND, A1, Us

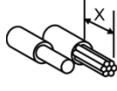

Stripping length (X)		8 mm
Connection type		M3 screw with box clamp
Rigid (solid & stranded)		1x 1.0 - 2.5 mm ² 1x 18 - 12 AWG
UL/CSA rated data		
Flexible with end sleeve		1x 0.5 - 2.5 mm ² 1x 20 - 12 AWG
Torque specification		Pozidriv 1 UL: 0.5Nm (4.4 lb-in) IEC: 0.4-0.5Nm (3.5-4.4 lb-in)

Connection Diagram

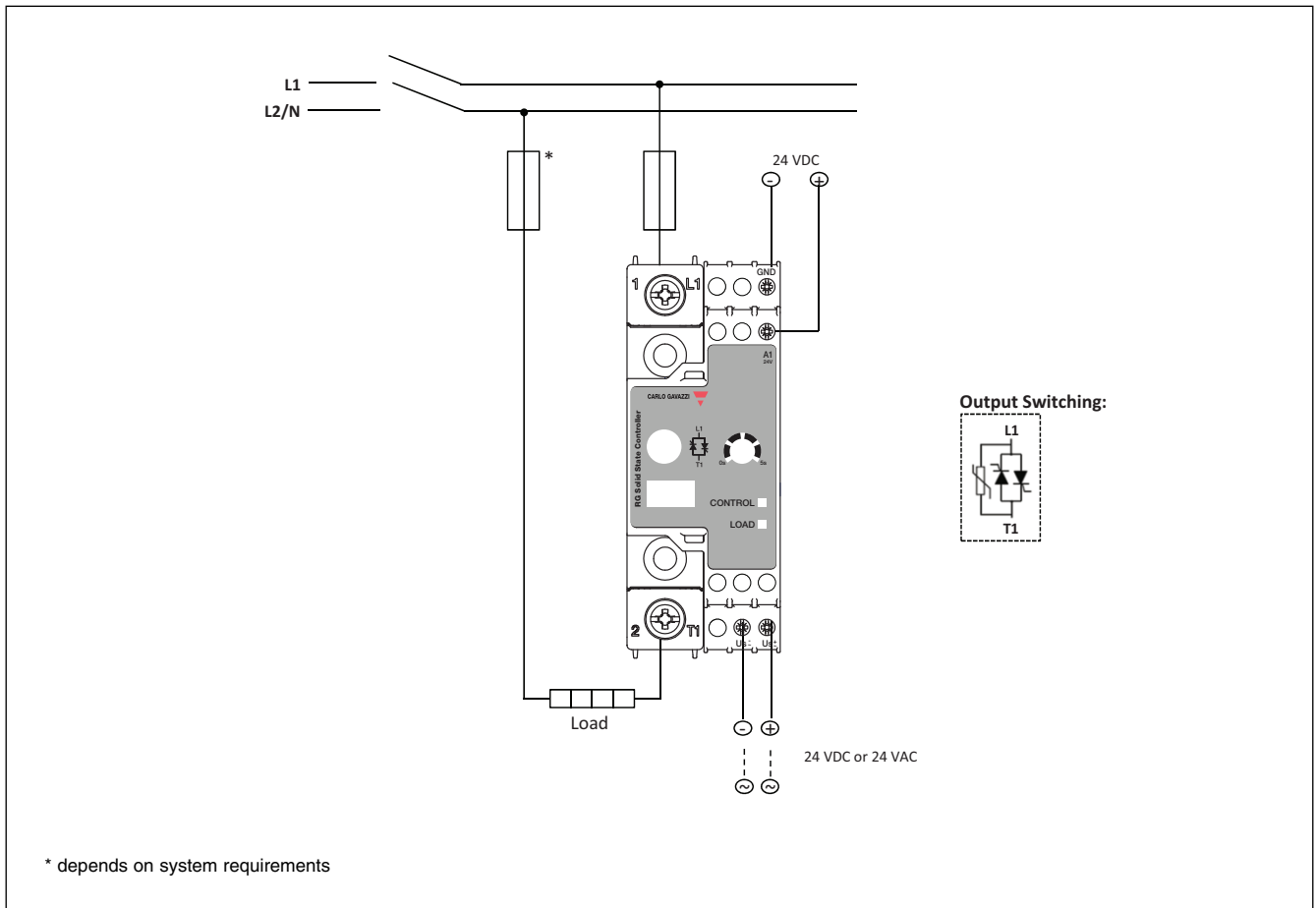

Short Circuit Protection

Protection Co-ordination, Type 1 vs Type 2:

Type 1 protection implies that after a short circuit, the device under test will no longer be in a functioning state. In type 2 co-ordination the device under test will still be functional after the short circuit. In both cases, however the short circuit has to be interrupted. The fuse between enclosure and supply shall not open. The door or cover of the enclosure shall not be blown open. There shall be no damage to conductors or terminals and the conductors shall not separate from terminals. There shall be no breakage or cracking of insulating bases to the extent that the integrity of the mounting of live parts is impaired. Discharge of parts or any risk of fire shall not occur.

The product variants listed in the table hereunder are suitable for use on a circuit capable of delivering not more than 100,000A Symmetrical Amperes, 600Volts maximum when protected by fuses. Tests at 100,000Arms were performed with Class J fuses, fast acting; please refer to the tables below for maximum ratings. Tests with Class J fuses are representative of Class CC fuses.

Co-ordination type 1 (UL508)

Part No.	Short circuit current [kArms]	Max. fuse size [A]	Class	Voltage [VAC]
RGS1P..50	100	30	J or CC	Max. 600
RGS1P..92	100	80	J	Max. 600

Co-ordination type 2 (EN/IEC 60947-4-3)

Part No.	Short circuit current [kArms]	Ferraz Shawmut (Mersen)		Siba		Voltage [VAC]
		Max. fuse size [A]	Part No.	Max. fuse size [A]	Part No.	
RGS1P..50	10	40	6.9xx CP GRC 22x58 /40	32	50 142 06.32	Max. 600
	100	40	6.9xx CP URD 22x58 /40	32	50 142 06.32	Max. 600
RGS1P..92	10	125	6.621 CP URQ 27x60 /125	125	50 194 20.125	Max. 600
	10	125	A70QS125-4	125	50 194 20.125	Max. 600
	100	125	6.621 CP URQ 27x60 /125	125	50 194 20.125	Max. 600
	100	125	A70QS125-4	125	50 194 20.125	Max. 600

xx = 00, without fuse trip indication

xx = 21, with fuse trip indication

Type 2 Protection with Miniature Circuit Breakers (M.C.B.s)

Solid State Relay type	ABB Model no. for Z - type M. C. B. (rated current)	ABB Model no. for B - type M. C. B. (rated current)	Wire cross sectional area [mm ²]	Minimum length of Cu wire conductor [m] ⁷
RGS1P..50	1 pole S201 - Z10 (10A)	S201-B4 (4A)	1.0	7.6
			1.5	11.4
			2.5	19.0
	S201 - Z16 (16A)	S201-B6 (6A)	1.0	5.2
			1.5	7.8
			2.5	13.0
			4.0	20.8
	S201 - Z20 (20A)	S201-B10 (10A)	1.5	12.6
			2.5	21.0
	S201 - Z25 (25A)	S201-B13 (13A)	2.5	25.0
4.0			40.0	
2 pole S202 - Z25 (25A)	S202-B13 (13A)	2.5	19.0	
		4.0	30.4	
RGS1P..92	1 pole S201-Z32 (32A)	S201-B16 (16A)	2.5	3.0
			4.0	4.8
			6.0	7.2
	S201-Z50 (50A)	S201-B25 (25A)	4.0	4.8
			6.0	7.2
			10.0	12.0
			16.0	19.2
	S201-Z63 (63A)	S201-B32 (32A)	6.0	7.2
			10.0	12.0
			16.0	19.2

7. Between MCB and Load (including return path which goes back to the mains).

Note: A prospective current of 6kA and a 230/400V power supply system is assumed for the above suggested specifications. For cables with different cross section than those mentioned above please consult Carlo Gavazzi's Technical Support Group.

Accessories

Tamper Proof Accessory Kit

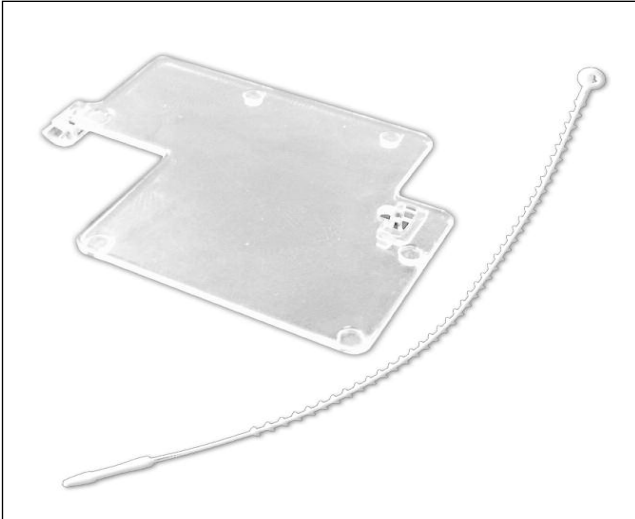

Ordering Key

RGTMP

Tamper proof accessory kit for RGS1P, RGC1P series containing:

- x5 transparent covers
- x5 secureness ties

Installation

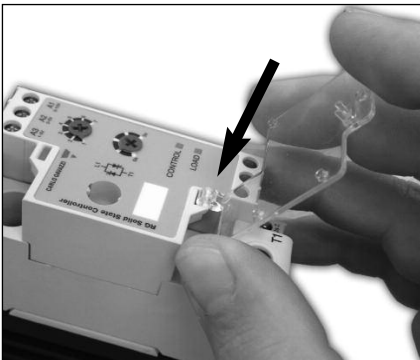

1: Clip hook of the transparent cover to the bottom loop of the RGx1P control module

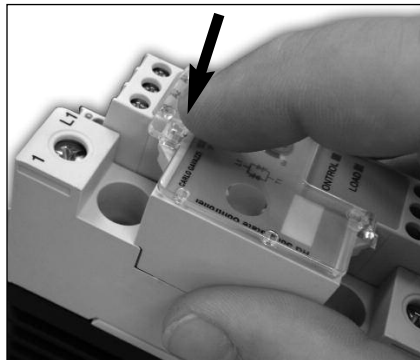

2: Close the cover by clipping to the top loop of the RGx1P control module

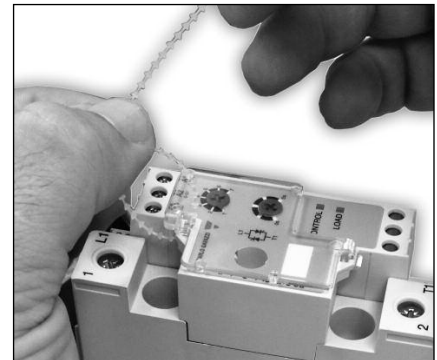

3: Secure with provided tie

Heatsink Selection

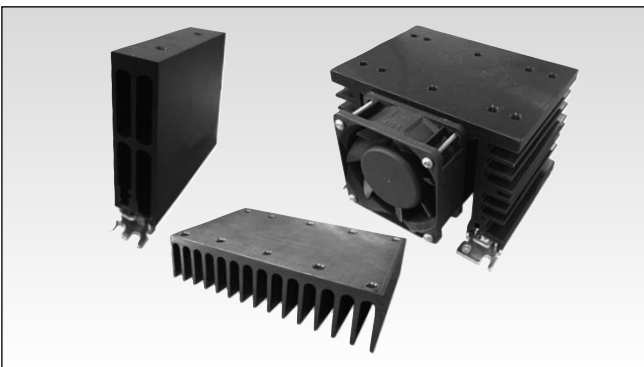

Ordering Key

RHS..

- Heatsinks and fans
- 5.40°C/W to 0.12°C/W thermal resistance
- DIN, panel or thru wall mounting
- Single or multiple SSR mounting

Heatsink Range Overview:

http://www.productselection.net/PDF/UK/ssr_accessories.pdf

Heatsink Selector Tool:

<http://www.productselection.net/heatsink/heatsinkselector.php?LANG=UK>

Thermal Pads



Ordering Key

RGHT

- Graphite thermal pad for RG series with adhesive on one side
- Width x Height x Thickness = 14 x 35 x 0.13 mm
- Packing qty. 10 pcs.

Thermal Paste

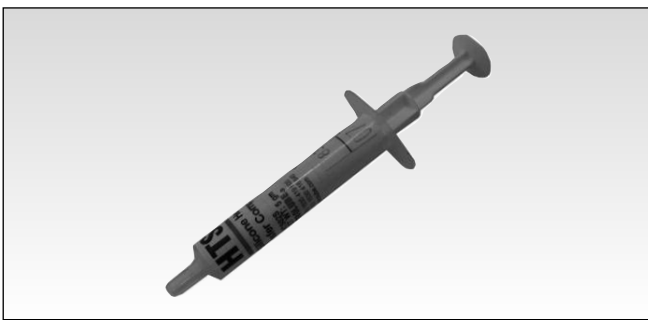

Ordering Key

HTS02S

- Silicone based thermal paste syringe
- Volume = 2ml
- Packing qty. 1 pc.

Screw Kits



Ordering Key

SRWKIT M5 X 30MM

- RGS Screw kit for mounting to heatsink
- Torx T20, size M5 x 30mm
- Packing qty: 20pcs.